

# E36300 Series Programmable DC Power Supplies



<b>Notices</b> .....	<b>5</b>
<b>Copyright Notice</b> .....	<b>5</b>
<b>Manual Part Number</b> .....	<b>5</b>
<b>Edition</b> .....	<b>5</b>
<b>Published by</b> .....	<b>5</b>
<b>Warranty</b> .....	<b>5</b>
<b>Technology Licenses</b> .....	<b>5</b>
<b>U.S. Government Rights</b> .....	<b>6</b>
<b>Third Party Licenses</b> .....	<b>6</b>
<b>Waste Electrical and Electronic Equipment (WEEE)</b> .....	<b>6</b>
<b>Declarations of Conformity</b> .....	<b>6</b>
<b>Safety Information</b> .....	<b>7</b>
<b>Safety and Regulatory Information</b> .....	<b>8</b>
<b>Safety Considerations</b> .....	<b>8</b>
<b>Safety Symbols</b> .....	<b>9</b>
<b>Regulatory Markings</b> .....	<b>10</b>
<b>South Korean Class A EMC declaration:</b> .....	<b>10</b>
<b>Safety and EMC Requirements</b> .....	<b>10</b>
<b>Environmental Conditions</b> .....	<b>11</b>
<b>1 Getting Started</b> .....	<b>13</b>
<b>Product Introduction</b> .....	<b>14</b>
Front panel at a glance .....	15
Rear panel at a glance .....	17
Meter view .....	18
Data logger view .....	20
Dimension diagram .....	21
Setup the instrument .....	21
<b>Prepare Instrument for Use</b> .....	<b>22</b>
Initial inspection .....	22
Standard shipped items .....	22
Documentation and firmware revisions .....	22
Recommended calibration interval .....	22
<b>Options and Fuse Information</b> .....	<b>23</b>
Ensure the correct AC input voltage and fuse settings .....	23
<b>Programming Ranges</b> .....	<b>25</b>
<b>Installation</b> .....	<b>26</b>
Connecting the power cord .....	26
Connecting the outputs .....	27
Parallel and series connections (E36312A and E36313A only) .....	30
4-wire sense connection (E36312A and E36313A only) .....	32
Interface Connections .....	34
Installing the optional GPIB interface (E36312A and E36313A only) .....	38
Rack mounting the instrument .....	39
<b>Remote Interface Configuration</b> .....	<b>40</b>
Keysight IO Libraries Suite .....	40
GPIB configuration .....	40
LAN configuration .....	41
Using sockets .....	46
More about IP addresses and dot notation .....	47
<b>Remote Control</b> .....	<b>48</b>

Web interface .....	48
Technical connection details .....	49
<b>Use the Built-in Help System .....</b>	<b>50</b>
View the help information for the front panel key .....	50
View the list of help topics .....	50
<b>Firmware Update .....</b>	<b>52</b>
<b>Front Panel Menu Reference .....</b>	<b>53</b>
<b>2 General Operating Information .....</b>	<b>54</b>
<b>Turning the Unit On .....</b>	<b>55</b>
View the error log .....	56
<b>Controlling the Outputs .....</b>	<b>57</b>
Step 1 - Select an output .....	57
Step 2 - Set the output voltage and current .....	57
Step 3 - Enable the output .....	58
Step 4 - View the output voltage and current .....	58
Constant voltage and constant current .....	59
<b>Using the Protection Function .....</b>	<b>60</b>
Protection function .....	60
Configuring protection .....	60
Clears and OVP and OCP Event .....	62
<b>Specifying 2-Wire or 4-Wire Sense (E36312A and E36313A Only) .....</b>	<b>63</b>
<b>Using the Tracking Operation .....</b>	<b>64</b>
<b>Configuring the Output Turn On Turn Off Sequence (E36312A and E36313A Only) .....</b>	<b>65</b>
Step 1 – Set the output voltage and current of the output channels: .....	65
Step 2 – Configure the turn-on turn-off delays: .....	65
Step 3 – Coupling selected outputs: .....	65
Step 4 – Use the All Outputs On and Off keys: .....	66
<b>Specifying the Operation Mode (E36312A and E36313A Only) .....</b>	<b>67</b>
<b>Using the Digital Control Port (E36312A and E36313A Only) .....</b>	<b>68</b>
Bi-directional digital IO .....	68
Digital input .....	70
Fault output .....	70
Inhibit input .....	71
Fault/inhibit system protection .....	72
Trigger input .....	73
Trigger output .....	74
Output couple controls .....	74
<b>Using the Output LIST (E36312A and E36313A Only) .....</b>	<b>77</b>
Step 1– Add/remove steps to/from the LIST .....	77
Step 2 – Configure the output sequence .....	78
Step 3 – Run the output sequence list .....	80
<b>Using the Data Logger Function (E36312A and E36313A Only) .....</b>	<b>82</b>
Logging data .....	82
Step 1 – Program the sequence for the output channels .....	82
Step 2 – Configure the data logger traces .....	83
Step 3 – Configure the data logger properties .....	84
Step 4 – Turn on Output 1, start the sequencing and log the data. ....	84
Step 5 – Export the data .....	85
Data logger view .....	86
Adjusting the waveform display .....	87
Data logger properties and waveform settings .....	88

---

Save the datalog .....	90
<b>Locking/Unlocking the Front Panel .....</b>	<b>93</b>
<b>Capturing a Screen .....</b>	<b>93</b>
<b>Enabling the E3631A Mode .....</b>	<b>94</b>
<b>Utilities Menu .....</b>	<b>95</b>
<b>Utilities Menu - Store and Recall State .....</b>	<b>95</b>
Store Settings .....	96
Recall Settings .....	98
Power On Setting .....	99
Set to Defaults .....	99
<b>Utilities Menu - I/O Configuration .....</b>	<b>100</b>
LAN Settings .....	100
Digital IO (E36312A and E36313A only) .....	101
GPIB (optional and applicable to E36312A and E36313A only) .....	101
<b>Utilities Menu - Test / Setup .....</b>	<b>102</b>
Calibration .....	102
Self Test .....	102
User Settings .....	103
Low Range .....	104
Help .....	104
<b>Utilities Menu - Error .....</b>	<b>105</b>
<b>Utilities Menu - Manage Files .....</b>	<b>106</b>
Action .....	106
Browse .....	106
File Name .....	107
<b>3 Characteristics and Specifications .....</b>	<b>109</b>

# Notices

## Copyright Notice

© Keysight Technologies 2017-2018

No part of this manual may be reproduced in any form or by any means (including electronic storage and retrieval or translation into a foreign language) without prior agreement and written consent from Keysight Technologies as governed by United States and international copyright laws.

## Manual Part Number

E36311-90001

## Edition

Edition 4, August 2018

## Published by

Keysight Technologies  
Bayan Lepas Free Industrial Zone  
11900 Bayan Lepas, Penang  
Malaysia

## Warranty

THE MATERIAL CONTAINED IN THIS DOCUMENT IS PROVIDED "AS IS," AND IS SUBJECT TO BEING CHANGED, WITHOUT NOTICE, IN FUTURE EDITIONS. FURTHER, TO THE MAXIMUM EXTENT PERMITTED BY APPLICABLE LAW, KEYSIGHT DISCLAIMS ALL WARRANTIES, EITHER EXPRESS OR IMPLIED, WITH REGARD TO THIS MANUAL AND ANY INFORMATION CONTAINED HEREIN, INCLUDING BUT NOT LIMITED TO THE IMPLIED WARRANTIES OF MERCHANTABILITY AND FITNESS FOR A PARTICULAR PURPOSE. KEYSIGHT SHALL NOT BE LIABLE FOR ERRORS OR FOR INCIDENTAL OR CONSEQUENTIAL DAMAGES IN CONNECTION WITH THE FURNISHING, USE, OR PERFORMANCE OF THIS DOCUMENT OR OF ANY INFORMATION CONTAINED HEREIN. SHOULD KEYSIGHT AND THE USER HAVE A SEPARATE WRITTEN AGREEMENT WITH WARRANTY TERMS COVERING THE MATERIAL IN THIS DOCUMENT THAT CONFLICT WITH THESE TERMS, THE WARRANTY TERMS IN THE SEPARATE AGREEMENT SHALL CONTROL.

## Technology Licenses

The hardware and/or software described in this document are furnished under a license and may be used or copied only in accordance with the terms of such license.

## U.S. Government Rights

The Software is “commercial computer software,” as defined by Federal Acquisition Regulation (“FAR”) 2.101. Pursuant to FAR 12.212 and 27.405-3 and Department of Defense FAR Supplement (“DFARS”) 227.7202, the U.S. government acquires commercial computer software under the same terms by which the software is customarily provided to the public. Accordingly, Keysight provides the Software to U.S. government customers under its standard commercial license, which is embodied in its End User License Agreement (EULA), a copy of which can be found at <http://www.keysight.com/find/sweula>. The license set forth in the EULA represents the exclusive authority by which the U.S. government may use, modify, distribute, or disclose the Software. The EULA and the license set forth therein, does not require or permit, among other things, that Keysight: (1) Furnish technical information related to commercial computer software or commercial computer software documentation that is not customarily provided to the public; or (2) Relinquish to, or otherwise provide, the government rights in excess of these rights customarily provided to the public to use, modify, reproduce, release, perform, display, or disclose commercial computer software or commercial computer software documentation. No additional government requirements beyond those set forth in the EULA shall apply, except to the extent that those terms, rights, or licenses are explicitly required from all providers of commercial computer software pursuant to the FAR and the DFARS and are set forth specifically in writing elsewhere in the EULA. Keysight shall be under no obligation to update, revise or otherwise modify the Software. With respect to any technical data as defined by FAR 2.101, pursuant to FAR 12.211 and 27.404.2 and DFARS 227.7102, the U.S. government acquires no greater than Limited Rights as defined in FAR 27.401 or DFAR 227.7103-5 (c), as applicable in any technical data.

## Third Party Licenses

Portions of this software are licensed by third parties including open source terms and conditions, copies of which may be found in <http://www.opensource.apple.com/source/CommonCrypto/CommonCrypto-7/Source/>.

## Waste Electrical and Electronic Equipment (WEEE)

This product complies with the WEEE Directive) marketing requirement. The affixed product label (see below) indicates that you must not discard this electrical/electronic product in domestic household waste.

Product Category: With reference to the equipment types in the WEEE directive Annex 1, this product is classified as “Monitoring and Control instrumentation” product. Do not dispose in domestic household waste.

To return unwanted products, contact your local Keysight office, or see

[about.keysight.com/en/companyinfo/environment/takeback.shtml](http://about.keysight.com/en/companyinfo/environment/takeback.shtml) for more information.



## Declarations of Conformity

Declarations of Conformity for this product and for other Keysight products may be downloaded from the Web. Go to <https://regulations.about.keysight.com/DoC/default.htm>. You can then search by product number to find the latest Declaration of Conformity.

## Safety Information

### CAUTION

A CAUTION notice denotes a hazard. It calls attention to an operating procedure, practice, or the like that, if not correctly performed or adhered to, could result in damage to the product or loss of important data. Do not proceed beyond a CAUTION notice until the indicated conditions are fully understood and met.

---

### WARNING

A WARNING notice denotes a hazard. It calls attention to an operating procedure, practice, or the like that, if not correctly performed or adhered to, could result in personal injury or death. Do not proceed beyond a WARNING notice until the indicated conditions are fully understood and met.

---

# Safety and Regulatory Information

## Safety Considerations

The following general safety precautions must be observed during all phases of operation, service, and repair of this instrument. Failure to comply with these precautions or with specific warnings elsewhere in this manual violates safety standards of design, manufacture, and intended use of the instrument. Keysight Technologies assumes no liability for the customer's failure to comply with these requirements.

---

**WARNING** BEFORE APPLYING POWER

- Verify that the product is set to match the available line voltage and that the correct fuse is installed. Use the label on the rear of the instrument to configure the power. See **Options and Fuse Information** for additional details.
- Ensure the mains supply voltage fluctuation do not exceed  $\pm 10\%$  of the nominal supply voltage.

---

**GROUND THE INSTRUMENT**

This product is a Safety Class I instrument (provided with a protective earth terminal). To minimize shock hazard, the instrument chassis and cabinet must be connected to an electrical ground. The instrument must be connected to the AC power supply mains through a three-conductor power cable, with the third wire firmly connected to an electrical ground (safety ground) at the power outlet. Any interruption of the protective(grounding) conductor or disconnection of the protective earth terminal will cause a potential shock hazard that could result in personal injury. If the instrument is to be energized via an external autotransformer for voltage reduction, be certain that the autotransformer common terminal is connected to the neutral (earthed pole) of the AC power lines (supply mains).

---

**DO NOT OPERATE IN AN EXPLOSIVE ATMOSPHERE OR WET ENVIRONMENTS**

Do not operate the device around flammable gases or fumes, vapor, or wet environments.

---

**DO NOT OPERATE DAMAGED OR DEFECTIVE INSTRUMENTS**

Instruments that appear damaged or defective should be made inoperative and secured against unintended operation until they can be repaired by qualified service personnel.

---

**DO NOT SUBSTITUTE PARTS OR MODIFY INSTRUMENT**

Because of the danger of introducing additional hazards, do not install substitute parts or perform any unauthorized modification to the instrument. Return the instrument to a Keysight Technologies Sales and Service Office for service and repair to ensure that safety features are maintained. To contact Keysight for sales and technical support, refer to the support links on the following Keysight website: [www.keysight.com/find/assist](http://www.keysight.com/find/assist) (worldwide contact information for repair and service).

---

**USE THE POWER CORD PROVIDED**

Use the device with the power cord provided with the shipment.

---

**USE THE DEVICE AS SPECIFIED**

If the device is used in a manner not specified by manufacturer, the device protection may be impaired.

---

**DO NOT BLOCK VENTILATION HOLES**

Do not block any of the ventilation holes of the device.

---

**OBSERVE ALL DEVICE MARKINGS BEFORE CONNECTING TO DEVICE**

Observe all markings on the device before connecting any wiring to the device.

---



**WARNING** TURN DEVICE OFF BEFORE CONNECTING TO OUTPUT TERMINALS  
Turn off the device power before connecting to the output terminals.

---

ENSURE COVER IS SECURED IN PLACE  
Do not operate the device with the cover removed or loosened.

---

TURN DEVICE OFF AND REMOVE ALL CONNECTIONS BEFORE INSTALLING THE GPIB INTERFACE  
Turn off the power and remove all connections, including the power cord, from the instrument prior installation of the GPIB interface.

---







**CAUTION** CLEAN WITH SLIGHTLY DAMPENED CLOTH  
Clean the outside of the instrument with a soft, lint-free, slightly dampened cloth. Do not use detergent, volatile liquids, or chemical solvents.

---

**NOTE** Connect USB cable with ferrite core to the rear panel USB port of the instrument.

---

## Safety Symbols

Symbol	Description
	Caution, risk of danger (refer to the manual for specific Warning or Caution information)
	Protective earth (ground) terminal.
	Frame or chassis (ground) terminal.
	Standby supply. The instrument is not completely disconnected from AC mains when switch is off.
	Alternating current (AC).
	Plus, positive polarity.
	Minus, negative polarity.

**WARNING** The WARNING sign denotes a hazard. It calls attention to a procedure, practice, or the like, which, if not correctly performed or adhered to, could result in personal injury. Do not proceed beyond a WARNING sign until the indicated conditions are fully understood and met.

---

**CAUTION** The CAUTION sign denotes a hazard. It calls attention to an operating procedure, or the like, which, if not correctly performed or adhered to, could result in damage to or destruction of part or all of the product. Do not proceed beyond CAUTION sign until the indicated conditions are fully understood and met.

---

**NOTE** The NOTE sign denotes important information. It calls attention to a procedure, practice, condition or the like, which is essential to highlight.

---

## Regulatory Markings

Symbol	Description
	The RCM mark is a registered trademark of the Australian Communications and Media Authority.
	The CE mark is a registered trademark of the European Community. This CE mark shows that the product complies with all the relevant European Legal Directives. ICES/NMB-001 indicates that this ISM device complies with the Canadian ICES-001. Cet appareil ISM est conforme a la norme NMB-001 du Canada. ISM GRP.1 Class A indicates that this is an Industrial Scientific and Medical Group 1 Class A product.
	This symbol indicates the time period during which no hazardous or toxic substance elements are expected to leak or deteriorate during normal use. Forty years is the expected useful life of the product.
	This symbol is a South Korean Class A EMC Declaration. This is a Class A instrument suitable for professional use and in electromagnetic environment outside of the home.
	The CSA mark is a registered trademark of the Canadian Standards Association.

### South Korean Class A EMC declaration:

Information to the user:

This equipment has been conformity assessed for use in business environments. In a residential environment this equipment may cause radio interference.

- This EMC statement applies to the equipment only for use in business environment.

사용자 안내문
이 기기는 업무용 환경에서 사용할 목적으로 적합성평가를 받은 기기로서 가정용 환경에서 사용하는 경우 전파간섭의 우려가 있습니다.

- 사용자 안내문은 “업무용 방송통신기자재”에만 적용한다.

### Safety and EMC Requirements

This power supply is designed to comply with the following safety and EMC (Electromagnetic Compatibility) requirements:

- Low Voltage Directive 2014/35/EU
- EMC Directive 2014/30/EU

## Environmental Conditions

The E36300 Series is designed for indoor use and in an area with low condensation. The table below shows the general environmental requirements for this instrument.

Environmental condition	Requirement
Temperature	Operating condition: 0 °C to 40 °C
	Storage condition: -20 °C to 70 °C
Humidity	Operating condition: Up to 80% RH at 40 °C (non-condensing)
	Storage condition: Up to 90% RH at 65 °C (non-condensing)
Altitude	Up to 2000 m
Pollution degree	2



# 1 Getting Started

Product Introduction

Prepare Instrument for Use

Options and Fuse Information

Programming Ranges

Installation

Remote Interface Configuration

Remote Control

Using the Built-in Help System

Firmware Update

Front Panel Menu Reference

This chapter gets you started with the E36300 Series programmable DC power supply.

## Product Introduction

The Keysight E36300 Series is a series of three DC bench and system power supplies. All three models include:

- Three outputs:
  - 6 V/5 A, +25 V/1 A, -25 V/1 A (E36311A)
  - 6 V/5 A, +25 V/1 A, +25 V/1 A (E36312A)
  - 6 V/10 A, +25 V/2 A, +25 V/2 A (E36313A)
- High performance functionality: accuracy, transient response, and rise/fall time
- Colorful, information-packed 4.3" LCD display
- Code compatible and works like the E3631A when in E3631A mode
- Three rack-units (3U), 1/2-rack form factor
- Low acoustic noise
- Excellent usability
- USB IO interface
- NISPOM security (Optional)
- Web Interface
- SCPI programmability
- BenchVue application
- 3-year warranty standard
- Keysight worldwide support

The model-specific features are shown below.

Feature	E36311A	E36312A	E36313A
Power output	80 W	80 W	160 W
IO interface	USB standard	USB/LAN standard, GPIB optional	USB/LAN standard, GPIB optional
Low current measurement		✓	✓
Output list capability		✓	✓
Data logging		✓	✓
Output sequencing		✓	✓
High power (160 W)			✓
Auto-Series/Parallel mode		✓	✓
Rear connections		✓	✓

## Front panel at a glance



Item	Description
1	Information-packed, high contrast LED display; easily viewable even from sharp angles
2	Output selection keys Selects an output to control. The lit key indicates the selected output. Tip: When this key is selected, pressing this key again will toggle between multiple and single output view.
3	Voltage/Current knobs Set the voltage and current of the selected output.
4	Meter View, Tracking and Store/Recall keys <ul style="list-style-type: none"> <li>– <b>[Meter View]</b> turns on the meter view for the selected output.</li> <li>– <b>[Tracking]</b> turns on or off the track mode for output 2 and 3. (E36312A and E36313A only)</li> <li>– <b>[Store/Recall]</b> opens the Store/Recall menu.</li> </ul>
5	Navigation keys. – Navigate through the control dialog windows; press <b>[Enter]</b> key to select a control.
6	Numeric keypad <ul style="list-style-type: none"> <li>– Enters numeric values. Press <b>[Enter]</b> key to complete the entry.</li> <li>– Deletes the values entered into the dialog using the back key.</li> </ul>
7	Output On key Turns individual outputs On or Off; outputs are on when the key is lit.
8	Output terminals

Item	Description
9	Earth ground reference
10	On/Standby key and LED indicator Turns on the instrument. If the LED is amber, the instrument is in standby mode with AC inlet power connected, and if it is green, the instrument is on.
11	All Output On/Off key Turns all outputs On and Off according to the specified turn-on and turn-off delays.
12	Softkeys Accesses the soft front panel menu.
13	USB port Allows an external USB drive to be connected to the instrument. (E36312A and E36313A only)



## Rear panel at a glance

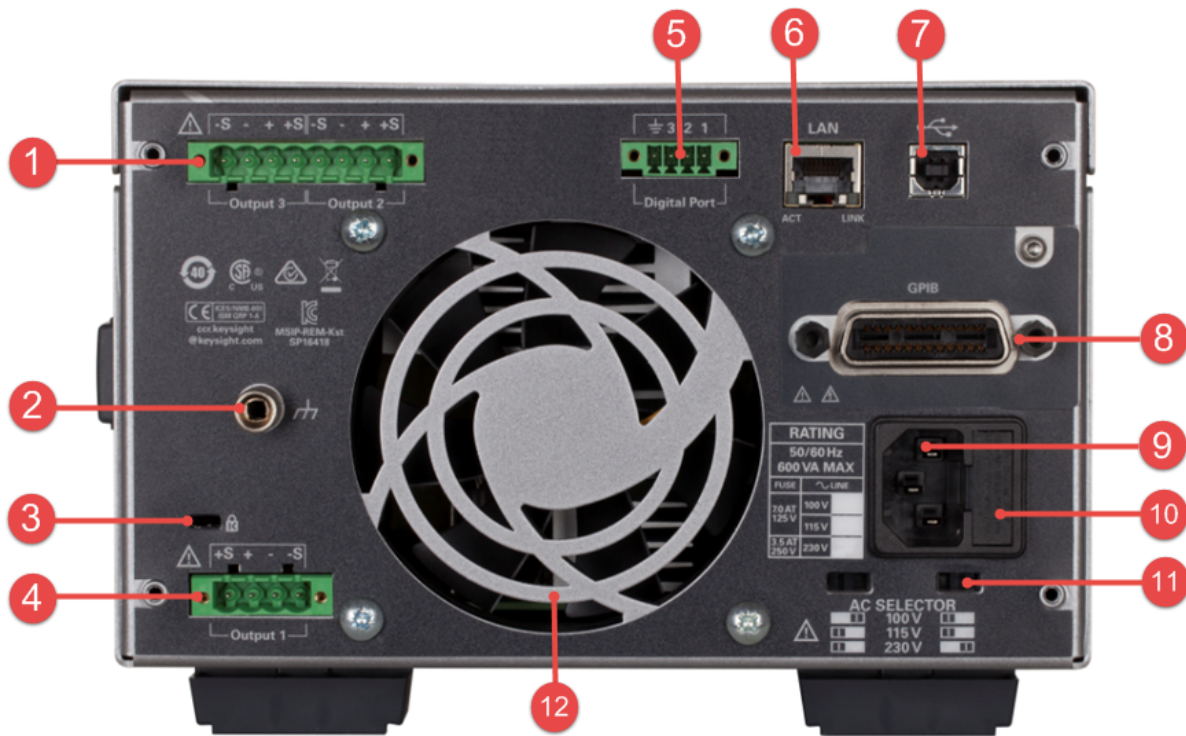





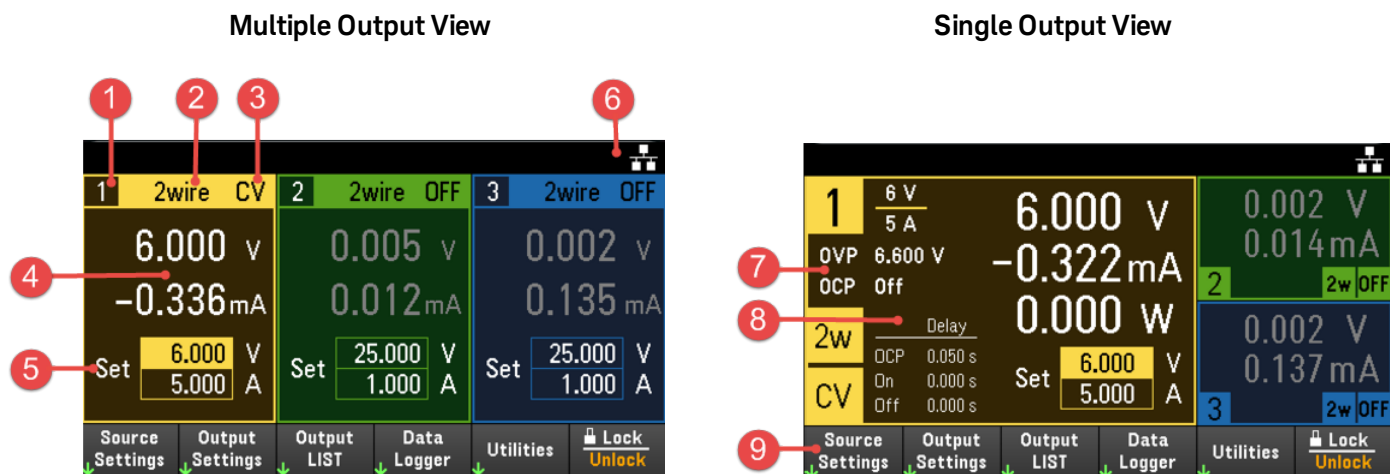

Item	Description
1	Output 2 and 3 terminal port (E36312A and E36313A only)
2	Earth ground reference (E36312A and E36313A only)
3	Kensington security slot
4	Output 1 terminal port (E36312A and E36313A only)
5	Digital I/O terminal port (E36312A and E36313A only)
6	LAN port (E36312A and E36313A only)
7	USB port
8	GPIB port (E36312A and E36313A Option GPIB only )
9	AC inlet
10	AC selector fuse-holder assembly
11	AC selector
12	Fan ventilation hole

## Meter view

The power supply's front panel features a high contrast LED display.

Press **[Meter View]**. This key toggles between multiple and single output view.



Item	Description
1	Output identifier When an output is selected, the background becomes highlighted. The selected output is displayed in an enlarged format in single output view.
2	Remote sense status 2wire or 4wire indicates that 2-wire or 4-wire sensing measurement is in use.
3	Output status OFF: The output is off CV: The output is in constant voltage mode CC: The output is in constant current mode UR: The output is unregulated OV: Over-voltage protection is tripped OC: Over-current protection is tripped OT: Over-temperature protection is tripped
4	Output meters Displays the actual output voltage and current. Displays power in single output view.
5	Output settings Displays the present output voltage and current settings. Use the numeric keypad or turn the front panel voltage or current knob to adjust these settings.
6	Interface status  : The instrument is connected to USB.  : The instrument is connected to LAN.  (blinking): The instrument is under identification mode via remote interface.  : The instrument is not connected to LAN.  (blinking): The LAN connection is at fault.

Item	Description
7	Ratings and protection Displays the present over-voltage protection (OVP) setting and whether over-current protection (OCP) is on or off.
8	Output delay Displays the OCP, Output On and Output Off delay values.
9	Soft front panel menu

## Data logger view

Press **Data Logger** from the soft front panel menu.

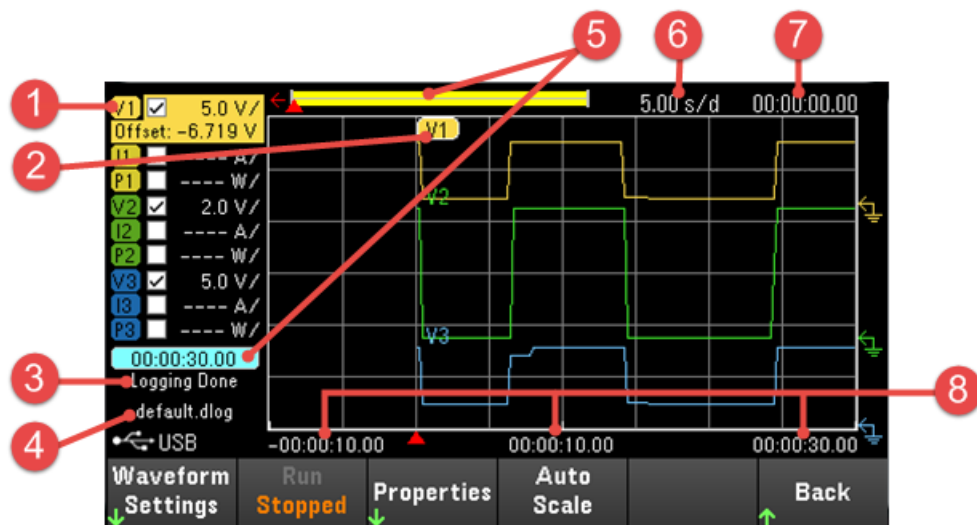

Item	Description
1	Trace controls Identifies the voltage or current trace that will be displayed. Dashes (---) indicate that the specified trace is turned off. Select the trace and press <b>[Enter]</b> to turn it on or off.
2	Output traces Voltage, current, or power traces. Voltage traces V1,V2 and V3 is shown. Press <b>Auto Scale</b> to auto scale all traces.
3	Status Indicates whether the Data Logger is logging data, done logging, or is empty.
4	Filename Indicates the file to which the data is being logged.
5	Data bar & time elapsed Displays the progress of the data logger. The yellow bar indicates the visible data. Numbers to the left indicate time elapsed/total duration.
6	Time/Div Indicates the horizontal time-base setting.
7	Offset time Indicates the time that the right gridline is offset or away from the end of the data log.
8	Grid time Displays the time on the gridline

## Dimension diagram

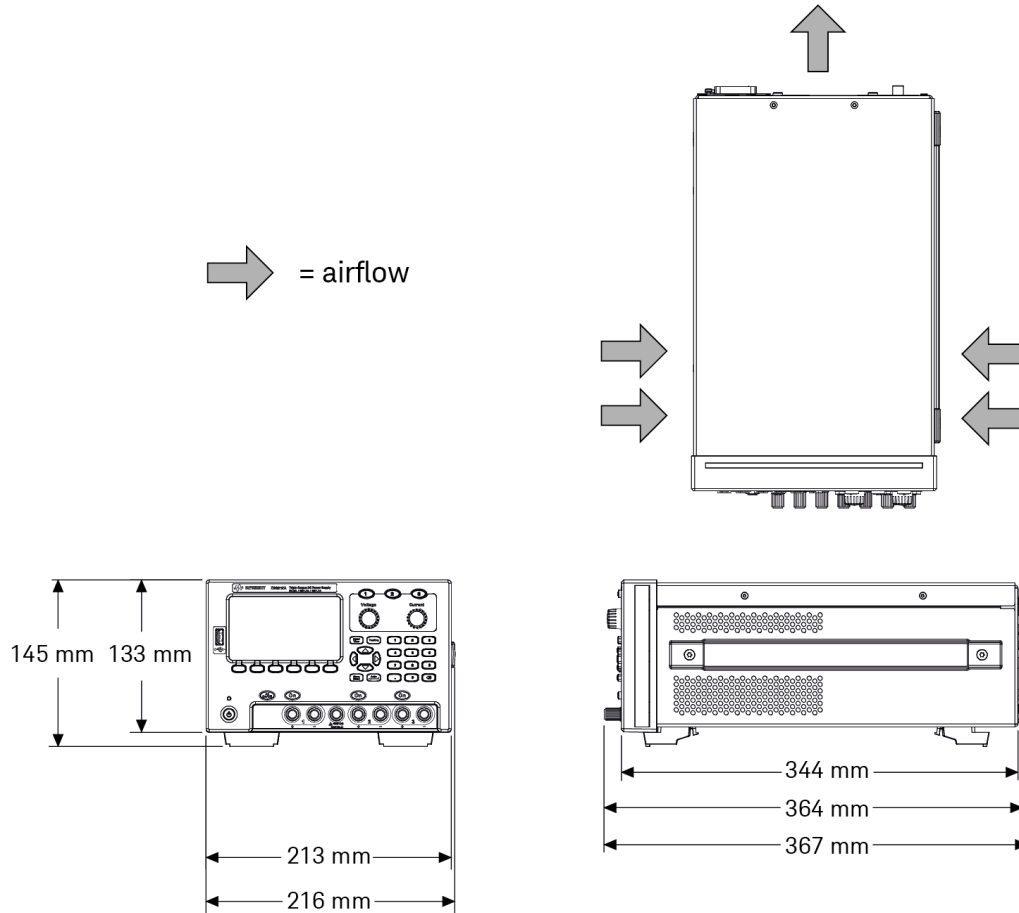

## Setup the instrument

Place the instrument's feet on a flat, smooth horizontal surface. Connect output to the front panel or connect output and sense leads to the rear panel (E36312A and E36313A only), being careful not to short the leads together. Attach the power cable to the rear panel, then plug it into main power. Connect LAN, USB or GPIB cables as desired, and you may also secure the instrument with a security lock cable.

Before disconnecting cables and cords from the instrument, turn the instrument off using the front-panel On/Standby key and disconnect from the supply source by unplugging the detachable power cord.

## Prepare Instrument for Use

### Initial inspection

When you receive your power supply, inspect it for any obvious damage that may have occurred during shipment. If there is damage, notify the shipping carrier and nearest Keysight Sales and Support Office immediately. Refer to [www.keysight.com/find/assist](http://www.keysight.com/find/assist).

Until you have checked out the power supply, save the shipping carton and packing materials in case the unit has to be returned. Check the list under **Standard Shipped Items** and verify that you have received these items with your instrument. If anything is missing, please contact your nearest Keysight Sales and Support Office.

### Standard shipped items

- Keysight E36311A/E36312A/E36313A DC power supply
- AC power cord
- Certificate of calibration
- One connector kit (P/N: E36312-89001) (E36312A and E36313A only):
  - One 10 A, 3.5 mm female 4-pin terminal block connector
  - One 12 A, 5 mm female 4-pin terminal block connector
  - One 12 A, 5 mm female 8-pin terminal block connector

### Documentation and firmware revisions

The Keysight E36300 Series documentation listed below can be downloaded for free through our website at [www.keysight.com/find/e36300manuals](http://www.keysight.com/find/e36300manuals).

- Keysight E36300 Series programmable DC Power Supplies User's Guide. This manual.
- Keysight E36300 Series programmable DC Power Supplies Programming Guide.
- Keysight E36300 Series programmable DC Power Supplies Service Guide.

For the latest firmware revision and firmware update instruction, go to [www.keysight.com/find/e36300firmware](http://www.keysight.com/find/e36300firmware).

### Recommended calibration interval

Keysight Technologies recommends a one year calibration cycle for the E36300 Series programmable DC power supplies.

## Options and Fuse Information

**WARNING** Ensure you order the proper instrument option for the mains power that will be used for the instrument.

Options OEM, OE3, and OE9 determine which power-line voltage is selected at the factory.

Option	Description
OEM	115 VAC $\pm$ 10%, 50/60 Hz input voltage
OE3	230 VAC $\pm$ 10%, 50/60 Hz input voltage
OE9	100 VAC $\pm$ 10%, 50/60 Hz input voltage

Ensure the correct AC input voltage and fuse settings

### Use the proper switch settings

To change the input AC voltage selector on the power supply, use the two AC selector switches on the underside of the power supply as shown.

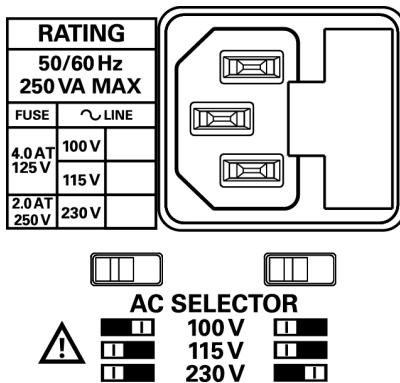

For example, to select 230 V, slide the left switch to the left and the right switch to the right, as illustrated in the diagram below the switches.

To select 115 V, slide both switches to the left, and to select 100 V, slide the two switches towards each other.

## Use the correct fuse

The following table describes the fuse that you should use with each of the power supply's option.

Option	Fuse part number	Description	Fuse type	Manufacturer	Application
E36311A-0E9 E36311A-0EM E36312A-0E9 E36312A-0EM	2110-1672	Fuse 4 A, 125 V Time-delay	Medium-Acting	Littelfuse	100 V and 115 V line voltage
E36311A-0E3 E36312A-0E3	2110-1640	Fuse 2 A, 250 V Time-delay	Slow-Blo		230 V line voltage
E36313A-0E9 E36313A-0EM	2110-1673	Fuse 7 A, 125 V Time-delay	Medium-Acting		100 V and 115 V line voltage
E36313A-0E3	2110-0954	Fuse 3.5 A, 250 V Time-delay	Slow-Blo		230 V line voltage

To configure the correct fuse, follow the three steps shown below:

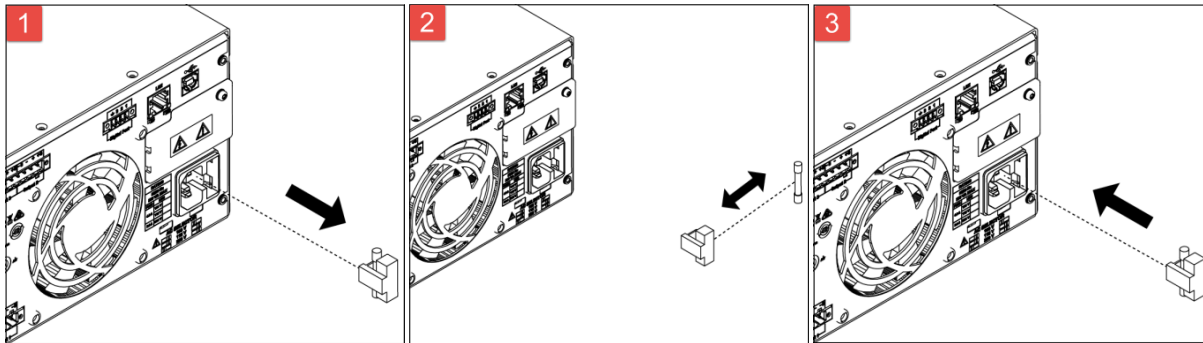

1 Pull the fuse holder out of the power supply.

2 Remove and insert the proper fuse into the fuse holder.

3 Re-insert the fuse holder into the power supply.



## Programming Ranges

The following table shows the maximum voltage, current, and power that can be programmed for each model.

Parameter		+6V output	+25V output	-25V output <sup>1</sup>
Output Identifier		P6V	P25V	N25V
Output Number		1	2	3
Voltage	MAXimum	6.18 V	25.75 V	0 V
	MINimum	0 V	0 V	-25.75 V
	DEFault (*RST)	0 V	0 V	0 V
Current	MAXimum	5.15 A 10.3 A <sup>2</sup>	1.03 A 2.06 A <sup>2</sup>	1.03 A 2.06 A <sup>2</sup>
	MINimum	0.001 A	0.001 A	0.001 A
	DEFault (*RST)	5 A 10 A <sup>2</sup>	1 A 2 A <sup>2</sup>	1 A 2 A <sup>2</sup>

Note:

1. Applicable for E36311A or when SCPI ID is set to E3631A (E36312A and E36313A). In normal operation, the E36312A and E36313A will output as +25 V.
2. Applicable for E36313A.

## Installation

Connecting the power cord

Connecting the outputs

Parallel and series connections

4-wire sense connection

Interface connections

Installing the optional GPIB interface

Rackmounting the instrument

### Connecting the power cord

#### **WARNING**

##### FIRE HAZARD

Use only the power cord that was supplied with your instrument. Using other types of power cords may cause overheating of the power cord, resulting in fire.

---

##### SHOCK HAZARD

The power cord provides a chassis ground through a third conductor. Be certain that your power outlet is of the three-conductor type with the correct pin connected to earth ground.

---

#### **NOTE**

Ensure the AC voltage setting on the rear panel is correctly set prior connecting the power cord.

---

Connect the power cord to the AC inlet connector on the rear of the unit. If the wrong power cord was shipped with your unit, contact your nearest Keysight Sales and Support Office.

Removing the power cord will disconnect AC input power to the unit.

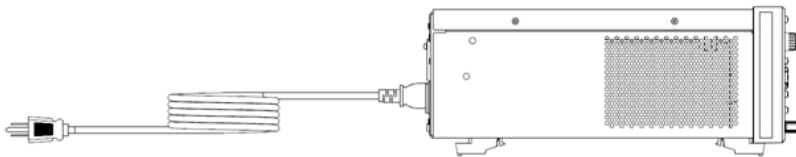

## Connecting the outputs

### NOTE

All loads should either be connected to the front panel binding post or rear panel output.

### Binding posts

#### WARNING

SHOCK HAZARD

Turn off AC power before connecting wires to the front panel. All wires and straps must be properly connected with the binding posts securely tightened.

The binding posts accept wires sizes up to AWG 14 in location (A). Securely fasten all wires by hand-tightening the binding posts. You can also insert standard banana plugs into the front of the connectors as shown in (B). A chassis ground binding post is located on the front panel for convenience.

Maximum current rating:

(A) = 20 A

(B) = 15 A

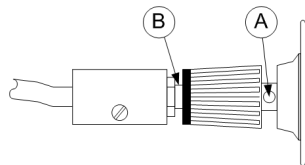

### Rear outputs connections

#### WARNING

SHOCK HAZARD

Turn off AC power before connecting wires to the rear panel. All wires and straps must be properly connected with the terminal block screws securely tightened.

Disconnect the connector plug to make your wire connections. The 12 A connector plug accepts wires sizes from AWG 12 to AWG 30. Wire sizes smaller than AWG 20 are not recommended. Connect the load wires to the + and - terminals. Connect the sense wires to the +s and -s terminals.

Securely fasten all wires by tightening the screw terminals. Insert the connector plug into the back of the unit. Secure the 12 A connector by tightening the locking screws. A chassis ground binding post is located next to the fan ventilation hole for ground connections.

Part number information for the connector kit is provided under [Standard Shipped Items](#).

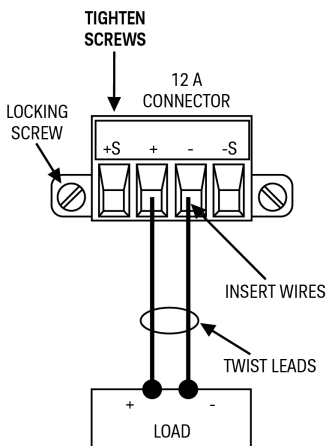

## Wire sizing

### WARNING

#### FIRE HAZARD

Select a wire size large enough to carry short-circuit current without overheating (refer to the following table). To satisfy safety requirements, load wires must be heavy enough not to overheat while carrying the short-circuit output current of the unit. .

---

AWG	Suggested maximum current (A) <sup>1</sup>	mΩ/ft	mΩ/m
12	25	1.59	5.2
14	20	2.53	8.3
16	13	4.02	13.2
18	10	6.39	21.0
20	7	10.2	33.5
22	5	16.1	52.8
24	3.5	25.7	84.3

Notes:

1. Single conductor in free air at 30 °C with insulation

## Output isolation

The outputs of all three power supplies are isolated from earth ground. Any output terminal may be grounded, or an external voltage source may be connected between any terminal output and ground. However, output terminals must be kept within  $\pm 240$  Vdc of ground. The  $\pm 25$  V supplies are tied together at one common terminal (Applies to E36311A or when the power supply is in E3631A mode). Any one of the three terminals can be tied to ground as needed. An earth ground terminal is provided on the front panel for convenience.

## Multiple loads

When connecting multiple loads to the power supply, each load should be connected to the output terminals using separate connecting wires. This minimizes mutual coupling effects between loads and takes full advantage of the low output impedance of the power supply. Each pair of wires should be as short as possible and twisted or shielded to reduce lead inductance and noise pick-up. If a shield is used, connect one end to the power supply ground terminal and leave the other end disconnected.

If cabling considerations require the use of distribution terminals that are located remotely from the power supply, connect output terminals to the distribution terminals by a pair of twisted or shielded wires. Connect each load to the distribution terminals separately.

### NOTE

For multiple load application, all loads should either be connected to the front panel binding post or rear panel output.

---

### CAUTION

Turn on AC power before connecting loads to prevent currents from damaging the loads.

---

### Front panel

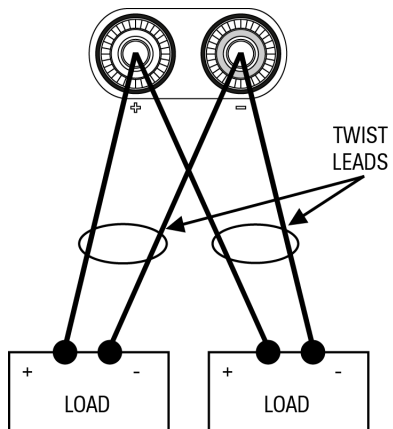

### Rear panel (E36312A and E36313A only)

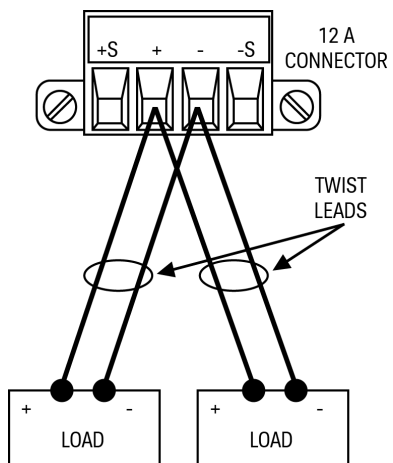

Parallel and series connections (E36312A and E36313A only)

### Parallel connections

### Series connections

### Parallel connections

**CAUTION** Only connect outputs that have identical voltage and current ratings in parallel.

Connecting outputs in parallel provides a greater current capability than can be obtained from a single output.

The following figures show how to connect two outputs when in Auto-Parallel mode.

#### Front panel

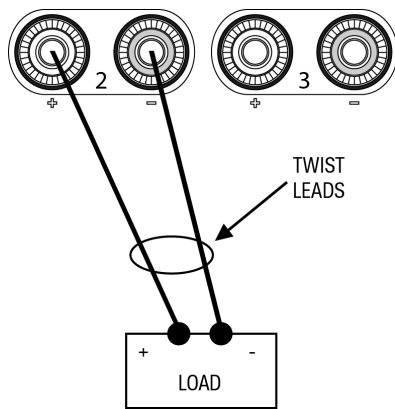

#### Rear panel

The figure on the left illustrates 2-wire sensing. If voltage drop in the load leads is a concern, the figure on the right shows how to connect the sense leads directly at the load.

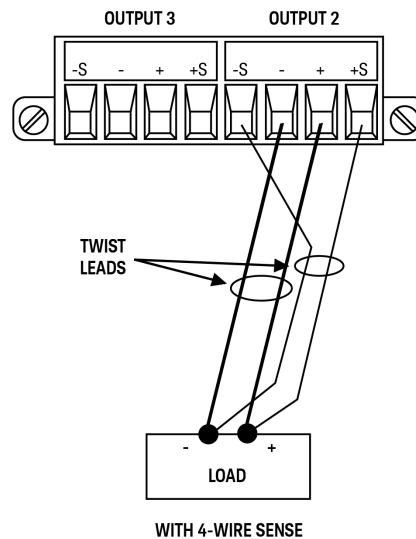
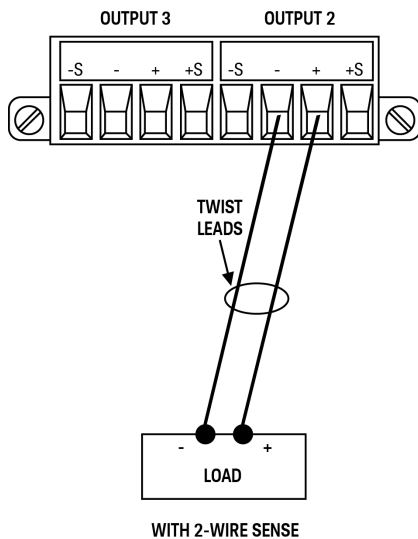

## Series connections

### WARNING

SHOCK HAZARD

Floating voltages must not exceed 240 VDC. No output terminal may be more than 240 VDC from chassis ground.

### CAUTION

Only connect outputs that have identical voltage and current ratings in series.

To prevent currents from damaging the power system when the load is connected, always turn series-connected outputs on and off together. Do not leave one output on while the other is off.

Connecting outputs in series provides a greater voltage capability than can be obtained from a single output.

The following figures show how to connect two outputs to a single load in Auto-Series mode.

#### Front panel

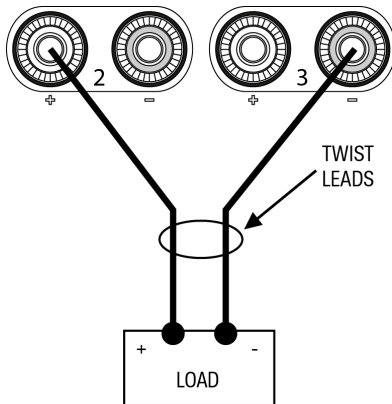

#### Rear panel

If voltage drop in the load leads is a concern, connect the sense leads of output 2 and output 3 for 4-wire sensing as shown in the figure on the right.

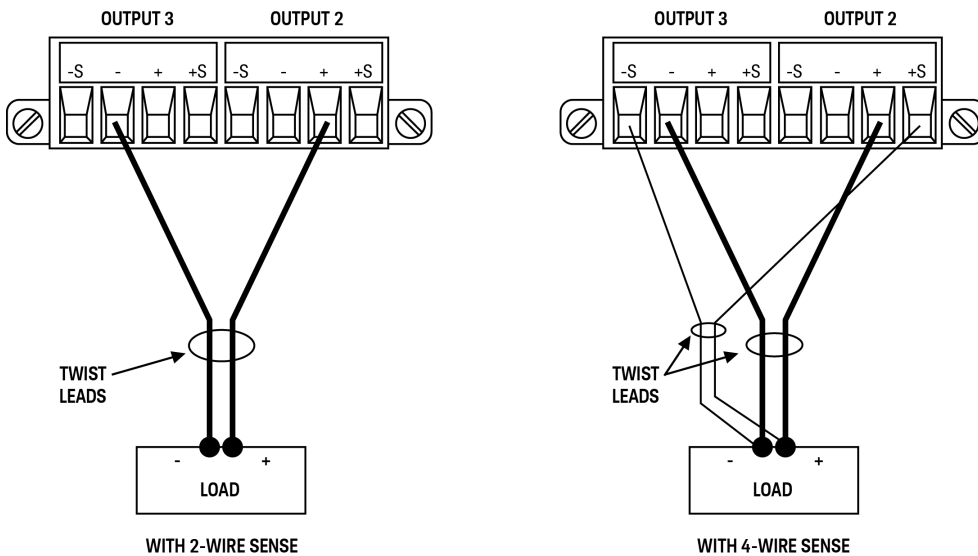

## 4-wire sense connection (E36312A and E36313A only)

### WARNING

#### SHOCK HAZARD

Turn off AC power before making rear panel connections. All wires and straps must be properly connected with the terminal block screws securely tightened

---

The power supply includes built-in relays that connect or disconnect the  $\pm$  sense terminals from their corresponding  $\pm$  output terminals. As shipped, the sense terminals are internally connected to the output terminals. This is referred to as 2-wire, or local sensing.

4-wire, or remote sensing improves the voltage regulation at the load by monitoring the voltage at the load rather than at the output terminals. This automatically compensates for the voltage drop in the load leads, which is especially useful for CV operation with load impedance that vary or have significant lead resistance. Because remote sensing is independent of other power supply functions, it can be used regardless of how the instrument is programmed. Remote sensing has no effect during CC operation.

The following figures illustrate load connections using 2-wire sensing and 4-wire sensing.

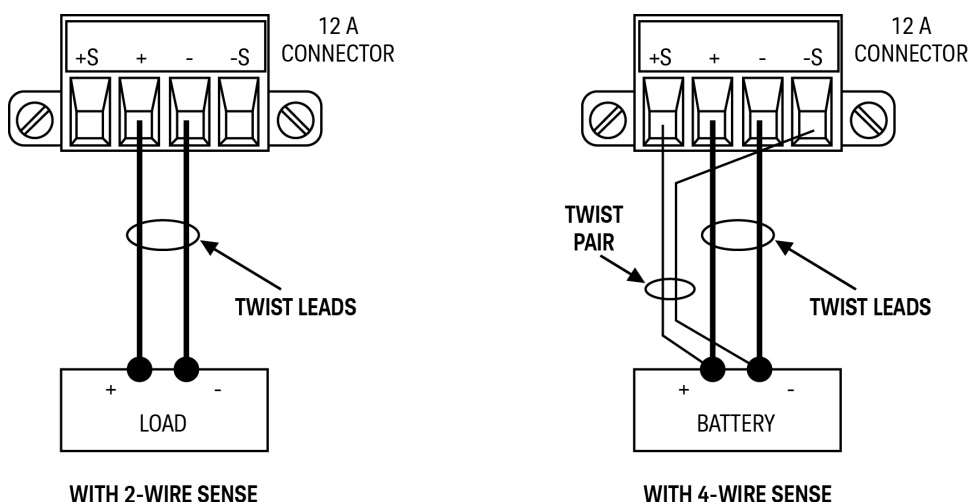

Connect the load to the output terminals using separate connecting wires. Keep the wire-pair as short as possible and twist or bundle it to reduce lead inductance and noise pickup. Keep the load leads under 14.7 meters (50 feet) per lead because of inductance effects.

Connect the sense leads as close to the load as possible. Do NOT bundle the sense wire-pair together with the load leads; keep the load wires and sense wires separate. The sense leads carry only a few milliamperes of current and can be a lighter gauge than the load leads. However, any voltage drop in the sense leads can degrade the voltage regulation of the instrument. Try to keep the sense lead resistance less than about 0.5  $\Omega$  per lead (this requires 20 AWG or heavier for a 50 foot length).

After turning the unit on, activate 4-wire remote voltage sensing by pressing **Source Settings** > **Sense 4w**. Refer to [Specifying 2-Wire or 4-Wire Sense](#).



## **Open sense leads**

The sense leads are part of the output's feedback path. Connect them in such a way so that they do not inadvertently become open circuited. The power supply includes protection resistors that reduce the effect of open sense leads during 4-wire-sensing. If the sense leads open during operation, the power supply returns to the local sensing mode, with the voltage at the output terminals approximately 5% higher than the programmed value.

## **Over-voltage protection considerations**

You must take into account any voltage drop in the load leads when setting the over-voltage trip point. This is because the OVP circuit senses at the output terminals and not at the sense terminals. Due to the voltage drop in the load leads, the voltage sensed by the OVP circuit could be higher than the voltage being regulated at the load.

## **Output noise considerations**

Any noise picked up on the sense leads will appear at the output terminals and may adversely affect CV load regulation. Twist the sense leads or use a ribbon cable to minimize the pickup of external noise. In extremely noisy environments it may be necessary to shield the sense leads. Ground the shield at the power supply end only; do not use the shield as one of the sensing conductors.

## Interface Connections

### GPIB connections

### USB connections

### LAN connections - site and private

### Digital port connections

This section describes how to connect to the various communication interfaces on your power supply. For further information about configuring the remote interfaces, refer to [Remote Interface Configuration](#).

#### NOTE

If you have not already done so, install the Keysight IO Libraries Suite, which can be found at [www.keysight.com/find/iolib](http://www.keysight.com/find/iolib). For detailed information about interface connections, refer to the Keysight Technologies USB/LAN/GPIB Interfaces Connectivity Guide included with the Keysight IO Libraries Suite.

### GPIB connections (optional for E36312A and E36313A)

The following figure illustrates a typical GPIB interface system.



1. If you do not have a GPIB interface card installed on your computer, turn off your computer and install the GPIB card.
2. Connect your instrument to the GPIB interface card using a GPIB interface cable.
3. Use the Connection Expert utility of the Keysight IO Libraries Suite to configure the GPIB card's parameters.
4. The power supply is shipped with its GPIB address set to 5. Use the front panel menu if you need to change the GPIB address.
5. You can now use Interactive IO within the Connection Expert to communicate with your instrument, or you can program your instrument using the various programming environments.

### USB connections

The following figure illustrates a typical USB interface system.

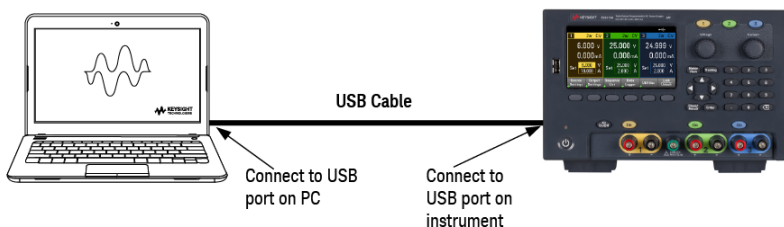

1. Connect your instrument to the USB port on your computer using a USB cable.
2. With the Connection Expert utility of the Keysight IO Libraries Suite running, the computer will automatically recognize the instrument. This may take several seconds. When the instrument is recognized, your computer will display the VISA alias, IDN string, and VISA address. This information is located in the USB folder. You can also view the instrument's VISA address from the front panel menu.
3. You can now use Interactive IO within the Connection Expert to communicate with your instrument, or you can program your instrument using the various programming environments.

### LAN connections - site and private (E36312A and E36313A only)

A **site LAN** is a local area network in which LAN-enabled instruments and computers are connected to the network through routers, hubs, and/or switches. They are typically large, centrally-managed networks with services such as DHCP and DNS servers. The following figure illustrates a typical site LAN system.

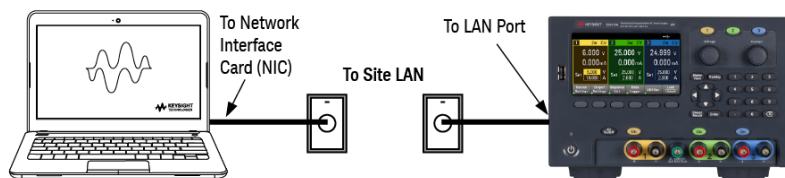

1. Connect the instrument to the site LAN or to your computer using a LAN cable. The as-shipped instrument LAN settings are configured to automatically obtain an IP address from the network using a DHCP server (DHCP is set On). The DHCP server will register the instrument's hostname with the dynamic DNS server. The hostname as well as the IP address can then be used to communicate with the instrument. The front panel **LAN** indicator will come on when the LAN port has been configured.

#### NOTE

If you need to manually configure any instrument LAN settings, refer to **Remote Interface Configuration** for information about configuring the LAN settings from the front panel of the instrument.

2. Use the Connection Expert utility of the Keysight IO Libraries Suite to add the power supply and verify a connection. To add the instrument, you can request the Connection Expert to discover the instrument. If the instrument cannot be found, add the instrument using its hostname or IP address.

#### NOTE

If this does not work, refer to "Troubleshooting Guidelines" in the Keysight Technologies USB/LAN/GPIB Interfaces Connectivity Guide included with the Keysight IO Libraries Suite.

3. You can now use Interactive IO within the Connection Expert to communicate with your instrument, or you can program your instrument using the various programming environments. You can also use the Web browser on your computer to communicate with the instrument as described under **Remote Control**.

A **private LAN** is a network in which LAN-enabled instruments and computers are directly connected, and not connected to a site LAN. They are typically small, with no centrally-managed resources. The following figure illustrates a typical private LAN system.

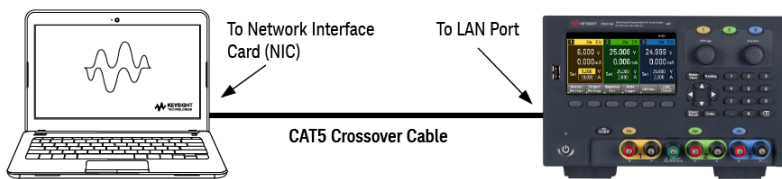

1. Connect the instrument to the computer using a LAN crossover cable. Alternatively, connect the computer and the instrument to a standalone hub or switch using regular LAN cables.

**NOTE**

Make sure your computer is configured to obtain its address from DHCP and that NetBIOS over TCP/IP is enabled. Note that if the computer had been connected to a site LAN, it may still retain previous network settings from the site LAN. Wait one minute after disconnecting it from the site LAN before connecting it to the private LAN. This allows Windows to sense that it is on a different network and restart the network configuration.

---

2. The factory-shipped instrument LAN settings are configured to automatically obtain an IP address from a site network using a DHCP server. You can leave these settings as they are. Most Keysight products and most computers will automatically choose an IP address using auto-IP if a DHCP server is not present. Each assigns itself an IP address from the block 169.254.nnn. Note that this may take up to one minute. The front panel LAN indicator will come on when the LAN port has been configured.

**NOTE**

Turning off DHCP reduces the time required to fully configure a network connection when the power supply is turned on. To manually configure the instrument LAN settings, refer to [Remote Interface Configuration](#) for information about configuring the LAN settings from the front panel of the instrument.

---

3. Use the Connection Expert utility of the Keysight IO Libraries Suite to add the power supply and verify a connection. To add the instrument, you can request the Connection Expert to discover the instrument. If the instrument cannot be found, add the instrument using its hostname or IP address.

**NOTE**

If this does not work, refer to “Troubleshooting Guidelines” in the Keysight Technologies USB/LAN/GPIB Interfaces Connectivity Guide included with the Keysight IO Libraries Suite.

---

4. You can now use Interactive IO within the Connection Expert to communicate with your instrument, or you can program your instrument using the various programming environments. You can also use the Web browser on your computer to communicate with the instrument as described under [Remote Control](#).

### Digital port connections (E36312A and E36313A only)

A 4-pin connector is provided on each instrument to access the three digital control port functions. The digital control connector accepts wire sizes from AWG 16 to AWG 22.

**NOTE**

It is good engineering practice to twist and shield all signal wires to and from the digital connectors. If shielded wire is used, connect only one end of the shield to the chassis ground to prevent ground loops.

---

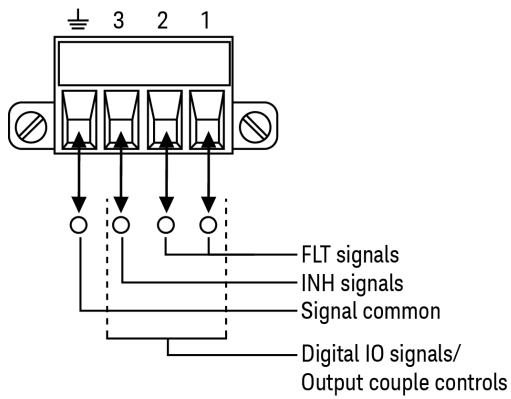

## Pin functions

The following table describes the possible pin configuration for the digital port functions. For a complete description of the electrical characteristics of the digital I/O port, refer to the product data sheet.

Pin function	Available configurable pins
Digital I/O and Digital In	Pins 1 through 3
External Trigger In/Out	Pins 1 through 3
Fault Out	Pin 1 and Pin 2
Inhibit In	Pin 3
Output Coupling	Pins 1 through 3
Common	Pin 4

In addition to the configurable pin functions, the active signal polarity for each pin is also configurable. When Positive polarity is selected, a logical true signal is a voltage high at the pin. When Negative polarity is selected, a logical true signal is a voltage low at the pin.

For more information on configuring the digital port functions, refer to [Using the Digital Control Port](#).

## Installing the optional GPIB interface (E36312A and E36313A only)

### WARNING

TURN OFF POWER AND REMOVE ALL CONNECTIONS PRIOR TO INSTALLATION

Turn off the power and remove all connections, including the power cord, from the instrument prior installation of the GPIB interface.

### RETAIN GPIB COVER PLATE

After installing the GPIB option, retain the cover plate for use in the event that you ever remove the GPIB option. The instrument should never be connected to power or inputs on the output terminals without either the GPIB module or the cover plate securely covering the rear-panel opening.

The following tools are required.

- T10 Torx driver

Make sure you turn the power supply upside down before proceed.

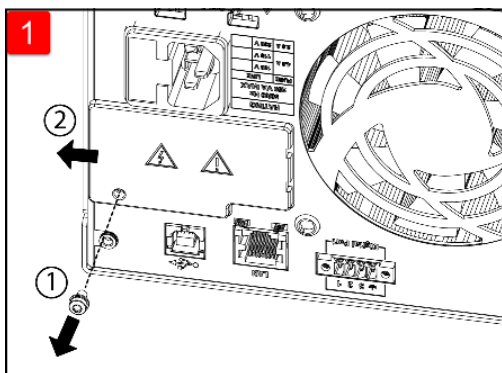

Use T10 Torx driver to remove the screw from the GPIB cover plate. Retain the screw for use later in this procedure.

Then, remove the cover plate by sliding it to the left.

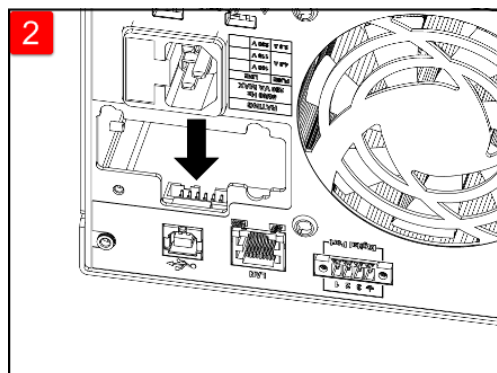

Locate the connector, just inside the unit, to connect the cable that is attached to the GPIB module.

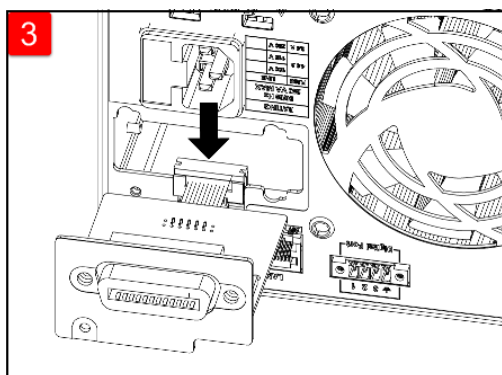

Attach the cable to the connector located in the previous step.

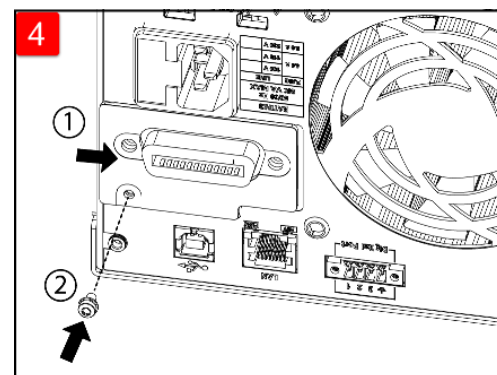

Put the module into the unit and slide the GPIB board to the right so that it is flushed against the instrument's sheet metal. Use the screw that was removed earlier to secure the GPIB plate in place.

This concludes the GPIB installation procedure.

## Rack mounting the instrument

### NOTE

Use the Rack Mount kit as stated below to rack mount the instrument. Installation instructions are provided with the rack mount kit.

### CAUTION

To prevent overheating, do not block airflow to or from the instrument. Allow enough clearance at the rear, sides, and bottom of the instrument to permit adequate internal air flow.

The power supply can be mounted in a standard 19-inch rack cabinet. They are designed to fit in three rack-units (3U) of space.

Remove the feet before rack mounting the unit. Do not block the air intake and exhausts at the sides and rear of the unit.

### Rack mounting a single instrument

To rack mount a single instrument, order adapter kit (1CM116A).

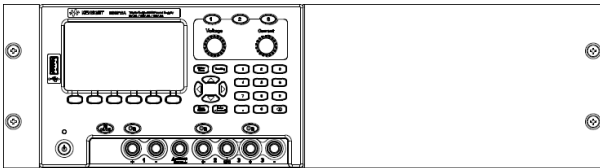

### Rack mounting instruments side-by-side

To rack mount two instruments side-by-side, order lock-link kit (5061-8769). Be sure to use the support rails in the rack cabinet.

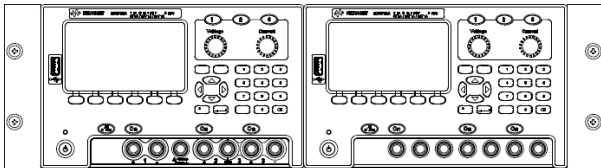

Rackmount kit without handles (1CM104A)

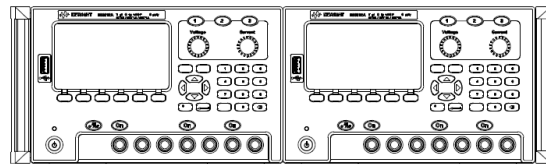

Front handle kit (1CN107A)

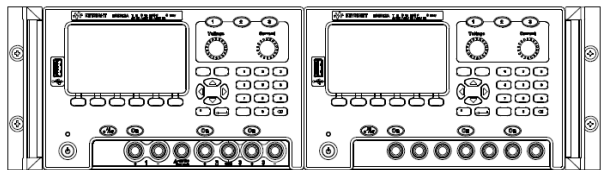

Rackmount kit with handles (1CP108A)

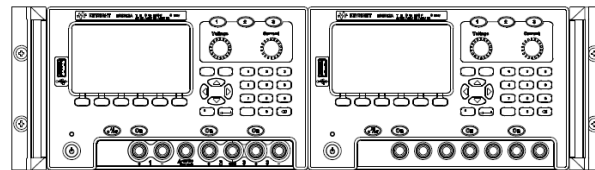

For instrument with previously supplied handles, order flange kit (1CM105A).

## Remote Interface Configuration

The instrument supports remote interface communication over three interfaces: USB, GPIB, and LAN.

- USB Interface: Use the rear-panel USB port to communicate with your PC.
- GPIB Interface: Set the instrument's GPIB address and connect to your PC using a GPIB cable.
- LAN Interface: By default, DHCP is on, which may enable communication over LAN. The acronym DHCP stands for Dynamic Host Configuration Protocol, a protocol for assigning dynamic IP addresses to networked devices. With dynamic addressing, a device can have a different IP address every time it connects to the network.

### Keysight IO Libraries Suite

#### NOTE

Ensure that the Keysight IO Libraries Suite is installed before you proceed for the remote interface configuration.

---

Keysight IO Libraries Suite is a collection of free instrument control software that automatically discovers instruments and allows you to control instruments over LAN, USB, GPIB, RS-232, and other interfaces. For more information, or to download IO Libraries, go to [www.keysight.com/find/iosuite](http://www.keysight.com/find/iosuite).

### GPIB configuration

#### NOTE

There are no SCPI commands to configure the GPIB parameter. All GPIB configuration must be done from the front panel.

---

Each device on the GPIB (IEEE-488) interface must have a unique whole number address between 0 and 30. The instrument ships with a default address of 5.

- This setting is non-volatile; it will not be changed by power cycling or \*RST or SYSTEM:PRESet.
  - Your computer's GPIB interface card address must not conflict with any instrument on the interface bus.
1. Press **Utilities** > **I/O Config** > **GPIB** to access the GPIB window.
  2. From this window, you can set the GPIB address using the numeric keys and press **[Enter]**.
  3. Press **Back** to exit.

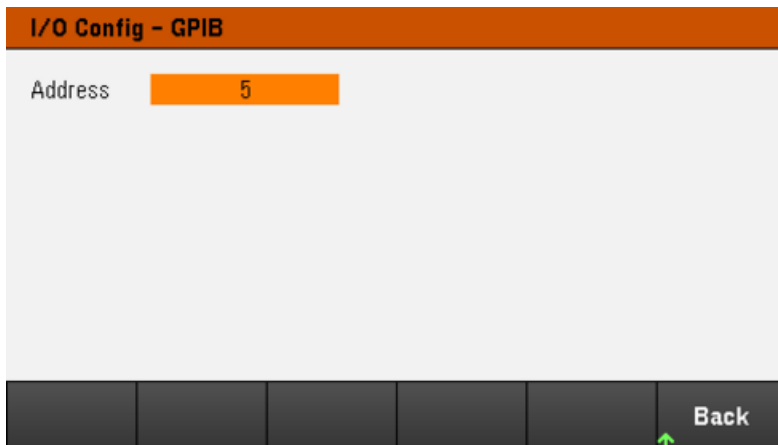



## LAN configuration

The following sections describe the primary front panel LAN configuration functions on the front-panel menu.

### NOTE

There are no SCPI commands to configure the LAN parameters. All LAN configuration must be done from the front panel.

After changing the LAN settings, you must save the changes. Press **Back** once you have complete the changes. You will be prompted to press **Yes** to save the LAN setting or **No** to exit without saving. Press **Yes** cycles power to the instrument and activates the settings. LAN settings are nonvolatile, they will not be changed by power cycling or \*RST. If you do not want to save your changes, press **No** to cancel all changes.

When shipped, DHCP is on, which may enable communication over LAN. The acronym DHCP stands for Dynamic Host Configuration Protocol, a protocol for assigning dynamic IP addresses to devices on a network. With dynamic addressing, a device can have a different IP address every time it connects to the network.

Some LAN settings require you to cycle instrument power to activate them. The instrument briefly displays a message when this is the case, so watch the screen closely as you change LAN settings.

### Viewing the LAN status

Press **Utilities** > **I/O Config** > **LAN Status** to view the LAN status.

The LAN status may be different from the front panel configuration menu settings - depending on the configuration of the network. If the settings are different, it is because the network has automatically assigned its own settings.

I/O Config - LAN Status			
LAN Status:	Running	DNS(1) Addr:	141.183.230.30
IP Source:	DHCP	DNS(2) Addr:	141.183.236.41
IP Addr:	10.116.33.151	TCPIP Port:	5025
Subnet Mask:	255.255.254.0	Telnet Port:	5024
Gateway:	10.116.32.1	MAC Addr:	00:30:03:1F:49:5E
Host Name:	K-E36312A		
Domain Name:	PNG.IS.KEYSIGHT.COM		
VISA Addr:	TCPIP::K-E36312A.png.is.keysight.com::inst0::INSTR		
mDNS Service:	Keysight E36312A DC Power Supply		
mDNS Hostname:	K-E36312A.local		
LAN Restart	LAN Reset		Back

### Restarting the LAN

Press **Utilities** > **I/O Config** > **LAN Status** > **LAN Restart** restarts the networking using ALL current LAN settings. LAN restart does not clear the Web interface password.

## Resetting the LAN

Press **Utilities** > **I/O Config** > **LAN Settings** > **Set to Default** resets the LAN settings to their factory default values. All default LAN settings are listed under Non-volatile Settings in Programming Guide.

Press **Utilities** > **I/O Config** > **LAN Status** > **LAN Reset** resets the LAN using its current settings and enables DHCP and DNS. The **LAN Reset** softkey also clears any user-defined Web Interface password.

## Modifying the LAN settings

As shipped from the factory, the instrument pre-configured settings should work in most LAN environments. Refer to Non-Volatile Settings in the Programming Guide for information on the factory-shipped LAN settings.

Press **Utilities** > **I/O Config** > **LAN Settings** to access the LAN Settings window. From this menu, you can manually configure the LAN settings.

I/O Config - LAN Setting										
IP Source	DHCP		AutoDNS	On						
IP Address	192	168	10	1	DNS(1) Addr	0	0	0	0	
Subnet Mask	255	255	255	0	DNS(2) Addr	0	0	0	0	
Gateway	192	168	10	1						
DNS Hostname	K-E36312A									
mDNS	On									
mDNS Service	Keysight E36312A DC Power Supply									
DHCP	Off	On	AutoDNS	Off	On	mDNS	Off	On	Set to Default	Back

## DHCP

DHCP (Dynamic Host Configuration Protocol) can automatically assign a dynamic IP address to a LAN device. This is typically the easiest way to configure the instrument for LAN.

– This setting is non-volatile; it will not be changed by power cycling or \*RST or SYSTEM:PRESet.

1. Press **Utilities** > **I/O Config** > **LAN Settings** > **DHCP On** to use DHCP to automatically assign an IP address.
2. Press **Back**. You will be prompted by the below message.

Press 'Yes' to save LAN setting and 'No' to exit without saving.

Yes	No
-----	----

3. Press **Yes** to save the setting.
4. Press **No** to cancel all the changes and exit without saving.

To manually set an IP address, Subnet Mask, or Default Gateway, press **DHCP Off**. Then, change the IP setup as described below.

#### **IP Address**

You can enter a static IP address for the instrument as a four-byte integer expressed in dot notation. Each byte is a decimal value, with no leading zeros (for example, 192.168.2.20).

- If DHCP is on, it attempts to assign an IP address to the instrument. If it fails, Auto-IP attempts to assign an IP address to the instrument.
  - Contact your LAN administrator for details.
  - This setting is non-volatile; it will not be changed by power cycling or \*RST or SYSTem:PRESet.
1. Press **Utilities** > **I/O Config** > **LAN Settings** > **DHCP Off**.
  2. Select IP Address field using the navigation keys. Set the desired IP address and press **Back**.
  3. Press **Yes** to save the setting.
  4. Press **No** to cancel all the changes and exit without saving.

#### **Subnet Mask**

Subnetting allows the LAN administrator to subdivide a network to simplify administration and minimize network traffic. The subnet mask indicates the portion of the host address used to indicate the subnet.

- Contact your LAN administrator for details.
  - This setting is non-volatile; it will not be changed by power cycling or \*RST or SYSTem:PRESet.
1. Press **Utilities** > **I/O Config** > **LAN Settings** > **DHCP Off**.
  2. Select Subnet Mask field using the navigation keys. Set the desired subnet mask address and press **Back**.  
(Example: 255.255.0.0)
  3. Press **Yes** to save the setting.
  4. Press **No** to cancel all the changes and exit without saving.

## Gateway

A gateway is a network device that connects networks. The default gateway setting is the IP address of such a device.

- You need not set a gateway address if using DHCP.
- Contact your LAN administrator for details.
- This setting is non-volatile; it will not be changed by power cycling or \*RST or SYSTem:PRESet.
  1. Press **Utilities** > **I/O Config** > **LAN Settings** > **DHCP Off**.
  2. Select Gateway field using the navigation keys. Set the appropriate gateway address and press **Back**.
  3. Press **Yes** to save the setting.
  4. Press **No** to cancel all the changes and exit without saving.

## DNS

DNS (Domain Name Service) is an Internet service that translates domain names into IP addresses. The DNS server address is the IP address of a server that performs this service.

- Normally, DHCP discovers DNS address information; you only need to change this if DHCP is unused or not functional. Contact your LAN administrator for details.
- This setting is non-volatile; it will not be changed by power cycling or \*RST or SYSTem:PRESet.
  1. Press **Utilities** > **I/O Config** > **LAN Settings** > **AutoDNS On** to configure the addressing of the instrument in DNS server automatically.
  2. Press **Utilities** > **I/O Config** > **LAN Settings** > **AutoDNS Off** to configure the addressing of the instrument manually.
  3. Select DNS(1) Addr and DNS(2) Addr using the navigation keys. These fields only appear when AutoDNS is set to Off.
  4. Set the desired primary and secondary address and press **Back**.
  5. Select mDNS Service field using the navigation keys.
  6. Press **Yes** to save the setting.
  7. Press **No** to cancel all the changes and exit without saving.

## DNS Hostname

A hostname is the host portion of the domain name, which is translated into an IP address.

Each power supply is shipped with a default hostname with the format: Keysight-modelnumber-serialnumber, where modelnumber is the power supply's 6-character model number (e.g. E36312A), and serialnumber is the last five characters of the 10-character power supply serial number located on the label on the top of the unit (e.g. 45678 if the serial number is MY12345678).

- The instrument receives a unique hostname at the factory, but you may change it. The hostname must be unique on the LAN.
- The name must start with letter; other characters can be an upper or lower case letters, numeric digits, or dashes ("-").
- This setting is non-volatile; it will not be changed by power cycling or \*RST or SYSTEM:PRESet.

1. Press **Utilities** > **I/O Config** > **LAN Settings**.
2. Select DNS Hostname field using the navigation keys. Press  and enter the hostname with the keyboard provided. Press **Back**.
3. Press **Yes** to save the setting.
4. Press **No** to cancel all the changes and exit without saving.

## mDNS Service

The mDNS service name is registered with the selected naming service.

Each power supply is shipped with a default service name with the format: Keysight-modelnumberserialnumber, where modelnumber is the power supply's 7-character model number (e.g. E36312A), and serialnumber is the last five characters of the 10-character power supply serial number located on the label on the top of the unit (e.g. 45678 if the serial number is MY12345678).

– The instrument receives a unique mDNS service name at the factory, but you may change it. The mDNS service name must be unique on the LAN.

– The name must start with letter; other characters can be an upper or lower case letters, numeric digits, or dashes ("-").

1. Press **Utilities** > **I/O Config** > **LAN Settings** > **mDNS Off** to configures the service name registered with the selected naming service automatically.
2. Press **Utilities** > **I/O Config** > **LAN Settings** > **mDNS On** to configure the service name of the instrument manually.
3. Select mDNS Service field using the navigation keys.
4. Press **mDNS Srv** and enter the service name with the keyboard provided.
5. Press **Back** to exit.

## Using sockets

### NOTE

Power supplies allow any combination of up to two simultaneous data socket, control socket, and telnet connections to be made.

Keysight instruments have standardized on using port 5025 for SCPI socket services. A data socket on this port can be used to send and receive ASCII/SCPI commands, queries, and query responses. All commands must be terminated with a newline for the message to be parsed. All query responses will also be terminated with a newline.

The socket programming interface also allows a control socket connection. The control socket can be used by a client to send device clear and to receive service requests. Unlike the data socket, which uses a fixed port number, the port number for a control socket varies and must be obtained by sending the following SCPI query to the data socket: `SYSTEM:COMMunicate:TCPIP:CONTrol?`

After the port number is obtained, a control socket connection can be opened. As with the data socket, all commands to the control socket must be terminated with a newline, and all query responses returned on the control socket will be terminated with a newline.

To send a device clear, send the string "DCL" to the control socket. When the power system has finished performing the device clear it echoes the string "DCL" back to the control socket.

Service requests are enabled for control sockets using the Service Request Enable register. Once service requests have been enabled, the client program listens on the control connection. When SRQ goes true the instrument will send the string "SRQ +nn" to the client. The "nn" is the status byte value, which the client can use to determine the source of the service request.

## More about IP addresses and dot notation

Dot-notation addresses ("nnn.nnn.nnn.nnn" where "nnn" is a byte value from 0 to 255) must be expressed with care, as most PC web software interprets byte values with leading zeros as octal (base 8) numbers. For example, "192.168.020.011" is equivalent to decimal "192.168.16.9" because ".020" is 16 expressed in octal, and ".011" (octal) is "9" (base 10). To avoid confusion, use only decimal values from 0 to 255, with no leading zeros.

## Remote Control

You can control the instrument via SCPI with Keysight IO Libraries or via a simulated front panel with the instrument's Web interface.

### Web interface

You can monitor and control the instrument from a Web browser by using the instrument's Web interface. To connect, simply enter the instrument's IP address or hostname in your browser's address bar and press Enter.

#### NOTE

If you see an error indicating 400: Bad Request, that is related to an issue with "cookies" in your Web browser. To avoid this issue, either start the Web interface by using the IP address (not hostname) in the address bar), or clear cookies from your browser immediately before starting the Web interface.

Description	
Model number	E36312A
Serial number	
Firmware revision	1.0.3-1.0.0-1.03
Description	Keysight E36312A DC Power Supply

VISA instrument addresses	
VXI-11 LAN protocol	TCPIP::K-E36312A.png.is.keysight.com::inst0::INSTR
TCP/IP SOCKET protocol	TCPIP::K-E36312A.png.is.keysight.com::5025::SOCKET
USB (USBTMC/488)	USB::0x2A8D::0x1102:::0::INSTR
GPIB	5

Check the checkbox below the picture of the instrument to enable an indicator on the instrument's front panel. This is helpful if you have several E36300 Series instruments and you wish to identify the one to which you are connected.

The Configure LAN tab on the top allows you to change the instrument's LAN parameters; exercise caution when doing so, as you may interrupt your ability to communicate with the instrument.

When you click the Control Instrument tab, the instrument will ask you for a password (default is *keysight*), and then it will open a new page, shown below.





This interface allows you to use the instrument just as you would from the front panel. Note the curved arrow keys that allow you to "rotate" the knob. You can press the arrow keys to rotate the knob clockwise and counter-clockwise, just as you would press any of the other keys on the front panel.

**WARNING**

READ WARNING

Be sure to read and understand the warning at the top of the Control Instrument page.

### Technical connection details

In most cases, you can easily connect to the instrument with the IO Libraries Suite or Web interface. In certain circumstances, it may be helpful to know the following information.

Interface	Details
VXI-11 LAN	VISA String: TCPIP0::<IP Address>::inst0::INSTR Example: TCPIP0::192.168.10.2::inst0::INSTR
Web UI	Port number 80, URL http://<IP address>/
USB	USB0::0x2A8D::<Prod ID>::<Serial Number>::0::INSTR Example: USB0::0x2A8D::0x0902::MY55160003::0::INSTR The vendor ID: 0x2A8D, the product ID is 0x0902, and the instrument serial number is MY55160003. The product ID varies by model: 0x1002 (E36311A), 0x1102 (E36312A), 0x1202 (E36313A).

## Use the Built-in Help System

The built-in help system provides context-sensitive help on any front panel key or menu softkey. A list of help topics is also available to help you learn about the instrument.

View the help information for the front panel key

### NOTE

Note that there is no help information available for [Meter View], Lock|Unlock and [Tracking] keys.

Press and hold any softkey or key, such as [All On/Off]. If the message contains more information than will fit on the display, press the down arrow softkey to scroll down.

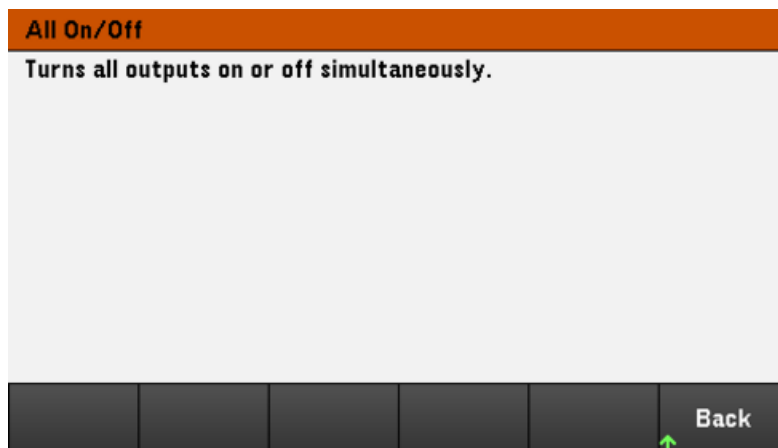

Press **Back** to exit.

View the list of help topics

Press **Utilities > Test / Setup > Help** to view the list of help topics. Press the arrow softkeys or use the front panel arrow keys to highlight the desired topic. Then press **Select**.

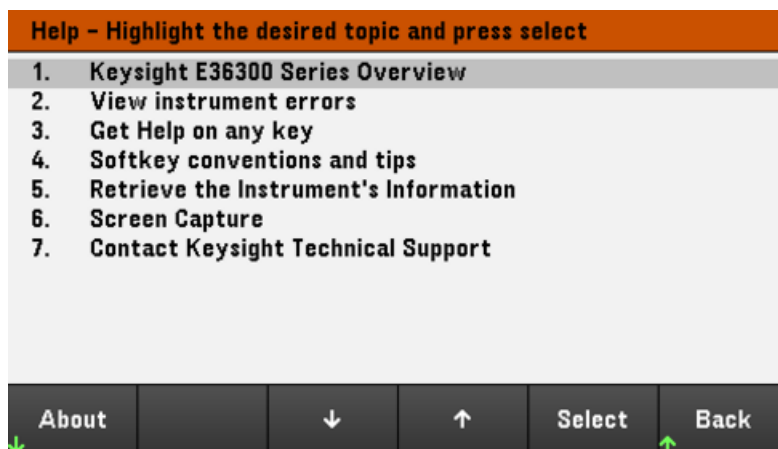

In this case, the following help topic appears:

**Softkeys Conventions and Tips**

1. The following conventions are used to simplify front panel menu use and navigation.
2. Help text references to softkeys are capitalized.
3. **OCP State**  
Off On Settings shown next to each other toggle between settings when softkey is pressed.
4. **Source Settings**  
A down arrow included with the softkey label indicates an additional menu level.
5. **Hostname**  
This symbol on the softkey label indicates an alphanumeric parameter entry using provided keyboard.

Back

### View the instrument model and serial number

Press **About** to view the instrument's model number, description and serial number.

**About**

**KEYSIGHT E36312A**  
Triple Output Programmable DC Power Supply  
6V,5A / 25V,1A / 25V,1A

**Serial number:**

**Firmware: 1.0.3-1.0.0-1.03**

Back

Press **Back** to exit.

#### NOTE

##### LOCAL LANGUAGE HELP

All front-panel keys' help, and help topics are available in English, French, German, Japanese, Korean, Chinese and Russian. To select the local language, press **Utilities > Test / Setup > User Settings > Display Options > Help Lang**. Then select the desired language. The menu softkey labels and status line messages are not translated.

---

## Firmware Update

**NOTE**

Do not turn off the instrument during the update.

---

1. Press **Utilities** > **Test / Setup** > **Help** > **About** to determine what instrument firmware version is currently installed.
2. Go to [www.keysight.com/find/e36300firmware](http://www.keysight.com/find/e36300firmware) to find the latest firmware version. If this matches the version installed on your instrument, there is no need to continue with this procedure. Otherwise, download the firmware update utility and a ZIP file of the firmware. Detailed firmware update instructions are located on the download page.

## Front Panel Menu Reference

This is an overview of the front-panel menus. Press the softkeys to access the front panel menus.

Menu heading	Description
<b>Source Settings &gt;</b>	
OCP State	Configures the over-current protection state.
OCP Delay Start	Configures the over-current protection delay start.
Protection Clear	Clears the protection function and returns the outputs to its previous operating state.
Sense	Configures the output sense. (E36312A and E36313A only)
<b>Output Settings &gt;(E36312A and E36313A only)</b>	
On Off Coupling >	Enables or disables the output coupling or synchronization between multiple output channels.
Output Inhibit >	Configures the inhibit input mode and Digital IO Pin 3.
Operation Mode >	Configures the output capability when two independent outputs are being used.
<b>Output LIST &gt;(E36312A and E36313A only)</b>	
Run Stopped	Runs or stops the output LIST.
Add	Inserts a new step to the list.
Delete	Deletes a specified step from the list.
Clear All	Clears all the steps in the list.
Properties >	Configures the output LIST settings.
<b>Data Logger &gt;(E36312A and E36313A only)</b>	
Waveform Settings	Adjusts waveform horizontally (time/division) or vertically (voltage/division, current/division or power-/division).
Waveform Horizontal >	Configures the data log horizontal settings.
Run Stopped	Runs or stops the data logger.
Properties...	Configures the data log traces and voltage and current measurement ranges for individual outputs. Also configures the data log duration, sample period, Min/Max values as well as trigger position.
Auto Scale	Auto-scales the traces on the display.
<b>Utilities &gt;</b>	
Store/Recall >	Saves and recalls instrument states.
I/O Config >	Displays and configures the I/O parameters for remote operations over the USB, LAN, GPIB or digital IO interface (product model dependent).
Test/Setup >	Accesses the self-test, calibration and help function as well as configures the user preferences and sets date and time.
Error >	Displays the instrument's error queue. Errors will be cleared after viewing or instrument reset.
Manage Files >	Creates, copies, deletes, and renames files and folders on a USB drive attached to the front panel. Also allows you to capture the current screen to either a bitmap (*.bmp) or portable network graphics (*.png) file.
<b>Lock Unlock</b>	Locks and unlocks the display.

# 2 General Operating Information

Turning the Unit On

Controlling the Outputs

Using the Protection Function

Specifying 2-Wire or 4-Wire Sense

Using the Tracking Operation

Configuring the Output Turn On Turn Off Sequence

Specifying the Operation Mode

Using the Digital Control Port

Using the Output LIST

Using the Data Logger Function

Locking/Unlocking the Front Panel

Capturing a Screen

Enabling the E3631A Mode

Utilities Menu

This chapter describes the general operating information of the E36300 Series.

## NOTE

The E36300 Series uses colors and numbers to let you easily identify information related to specific outputs. For example, all the configuration and display items related to output 1 are shown in the same color as the output selection key.

---

## Turning the Unit On

After you have connected the power cord, press the On/Standby key to turn the unit on. The front panel display lights up after a few seconds. When the front panel meter view appears, use the Voltage and Current knobs to enter voltage and current values. Output 1 is selected by default.

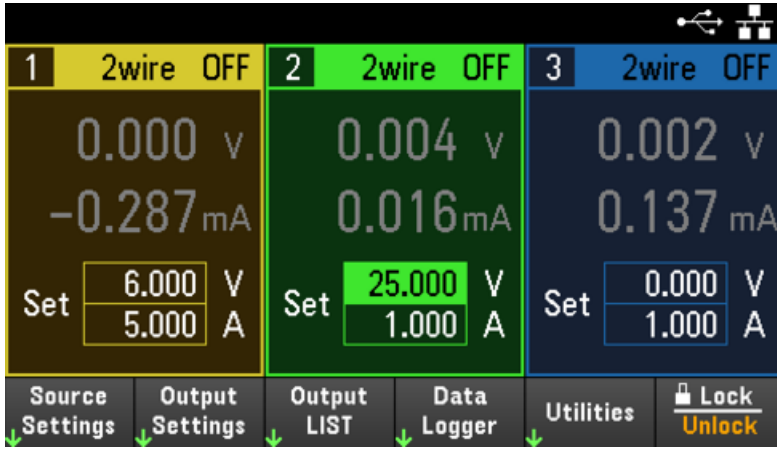

Press one of the three [On] keys to enable an individual output. In meter view, the power supply continuously measures and displays the output voltage and current of each output.

### NOTE

A power-on self-test occurs automatically when you turn the unit on. This assures you that the instrument is operational. If self-test fails, or if other operating problems occur with your instrument, the front panel error indicator (!Err) appears at the upper top of the display.

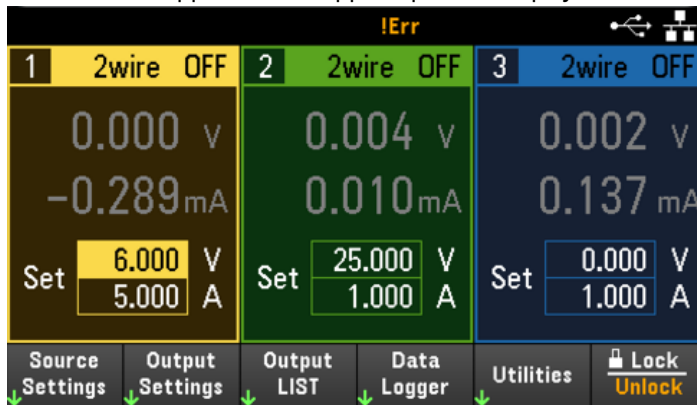

View the error log

Press **Utilities** > **Error** to display the error log. If there are more than 10 errors on the display, press **Next** to scroll to the next page.

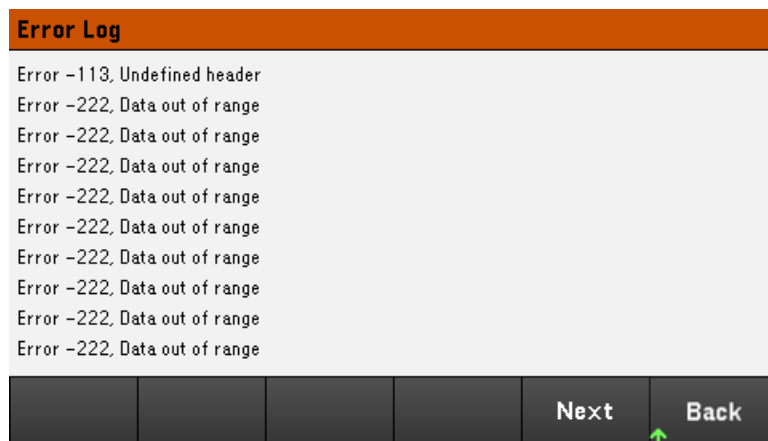

Press **Back** or **[Meter View]** to return to the meter-view display.

- Errors are stored in the order they are received. The error at the end of the list is the most recent error.
- If there are more than 20 errors in the queue, the last error stored is replaced with -350, "Queue overflow". No more errors are stored until you remove errors from the queue. If there are no errors, the instrument responds with +0, "No error".
- Except for self-test errors, errors are cleared when exiting the Error Log menu or when cycling power.

If you suspect that there is a problem with the power supply, refer to the Troubleshooting section in the Service Guide.



## Controlling the Outputs

### Step 1 - Select an output

Press one of the output selection keys to select an output to control. The lit key identifies the selected output. All subsequent output-specific front panel commands are sent to the selected output.



### Step 2 - Set the output voltage and current

Turn the Voltage and Current knobs. The output voltage or current setting changes when they are turned.



You can also enter the voltage and current values directly in the numeric entry fields (the Set fields) in the meter-view display. Use the navigation keys to select the field; use the numeric entry keys to enter the value. The value becomes active when you press **[Enter]**.

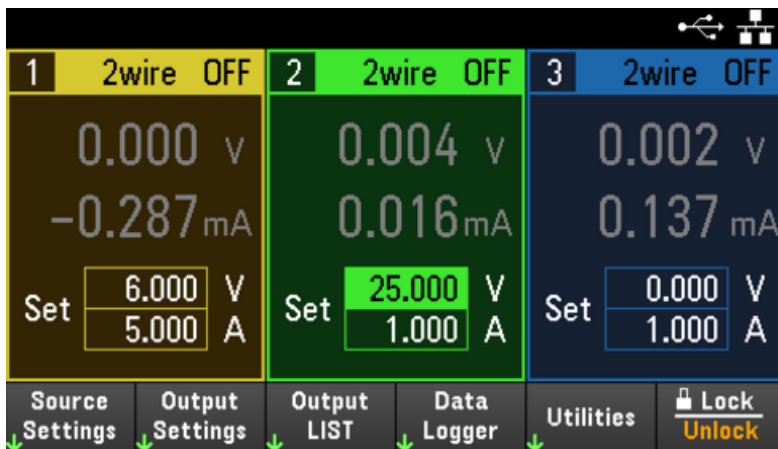

Lastly, you can press the **Source Settings** key to access the Source Settings window. Use the navigation keys to highlight the Voltage or Current fields. Then enter the voltage and current values with the numeric keys. You can use the Voltage and Current knobs to adjust the values in the Voltage and Current fields.

Press **[Enter]** to enter the value. Press **Back** to return to the meter-view display.

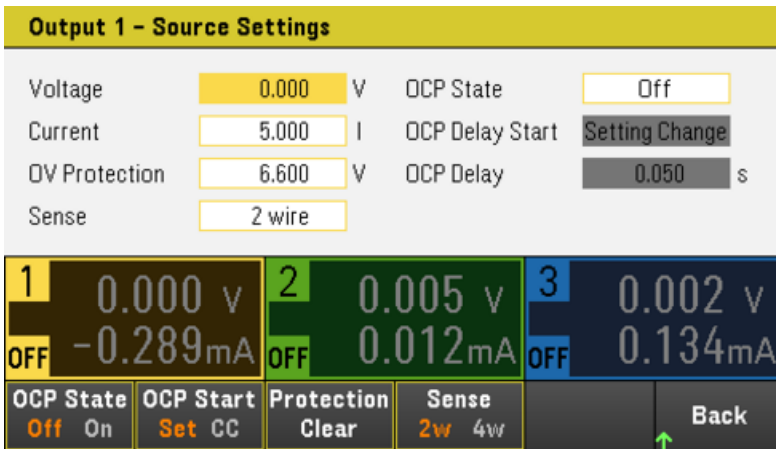

Table below indicates the output range and default value for voltage and current settings.

Settings	Output range	Default value
Voltage	Output 1: 0 to 6.18V Output 2: 0 to 25.75 V Output 3: 0 to 25.75 V	0 V
	When E3631A SCPI ID is selected, Output 1: 0 to 6.18 V Output 2: 0 to 25.75 V Output 3: 0 to - 25.75 V	
Current	<u>E36311A and E36312A</u> Output 1: 0.001 to 5.15 A Output 2: 0.001 to 1.03 A Output 3: 0.001 to 1.03 A	<u>E36311A and E36312A</u> Output 1: 5 A Output 2: 1 A Output 3: 1 A
	<u>E36313A</u> Output 1: 0.001 to 10.3 A Output 2: 0.001 to 2.06 A Output 3: 0.001 to 2.06 A	<u>E36313A</u> Output 1: 10 A. Output 2: 2 A Output 3: 2 A

### Step 3 - Enable the output

Press the color-coded **[On]** key to enable an individual output. When an output is on, the **[On]** key for that output is lit. When an output is off, the **[On]** key is not lit. The **[All On/Off]** key turn all outputs on or off simultaneously.

The state of a disabled output (output off) is a condition of zero output voltage and zero source current.

### Step 4 - View the output voltage and current

Press **[Meter View]** to view the output voltage and current. When an output is enabled, the front panel meters continuously measure and display the output voltage and current.

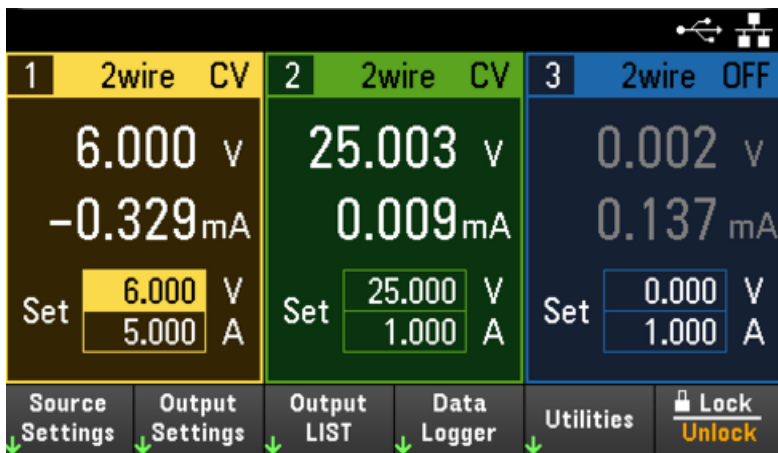

## Constant voltage and constant current

If the output load resistance exceeds the voltage setting divided by the current setting, the instrument will operate in constant-voltage (CV) mode. The current will equal the voltage divided by the load resistance.

If the output load resistance is less than the voltage setting divided by the current setting, the instrument will operate in constant-current (CC) mode. The voltage will equal the current multiplied by the load resistance.

### From the remote interface:

A channel parameter is required with each SCPI command to select an output. For example, (@1) selects output 1, (@2,3) selects output 2 and 3, and (@1:3) selects outputs 1 through 3. The output list must be preceded with an @ symbol and be enclosed in parentheses ().

To set only output 1 to 5 V and 1 A:

```
APPL Ch1 5, 1
```

To enable only output 1:

```
OUTP ON,(@1)
```

To enable output 1 and output 3:

```
OUTP ON,(@1,3)
```

To measure the output voltage and current of output 1:

```
MEAS:VOLT?(@1)
```

```
MEAS:CURR?(@1)
```

## Using the Protection Function

### Protection function

Each output has independent protection functions. A front panel status indicator will turn on when a protection function is set. Protection functions are latching, which means that they must be cleared once they are set.

Of the following protection functions, only OV and OC are user-programmable.

- **OV**: Over-voltage protection is a hardware OVP whose trip level is a programmable value. The OVP is always enabled.
- **OC**: Over-current protection is a programmable function that can be enabled or disabled. When enabled, the output will be disabled when the output current reaches the current limit setting.
- **OT**: Over-temperature protection monitors the temperature of each output and shuts down the output if any temperature exceeds the maximum factory-defined limits.

### Configuring protection

Protection functions are configured on the Source Settings window.

Press **Source Settings** to access the Source Settings window.

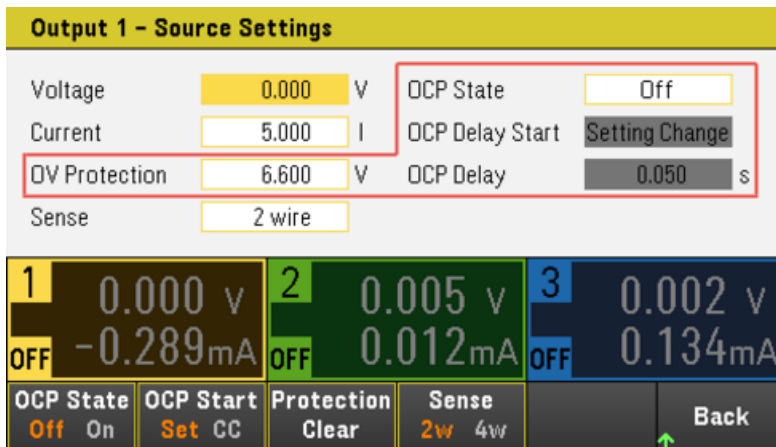

### OV Protection

Over-voltage protection disables the output if the output voltage reaches the OVP level.

To set the over-voltage protection, enter an over-voltage value in the OV Protection field.

#### NOTE

For E36311A or when SCPI ID is set to E3631A, you can program a negative over-voltage protection level which will disable the output when negative voltages are detected.

**NOTE**

The power supply's OVP circuit will program the output to zero whenever the overvoltage condition occurs. If external voltage source such as battery is connected across the output, and the overvoltage condition inadvertently occurs, the current from the voltage source will sink through the internal circuitry; possibly damaging the power supply. To avoid this, a diode must be connected in series with the output as shown below.

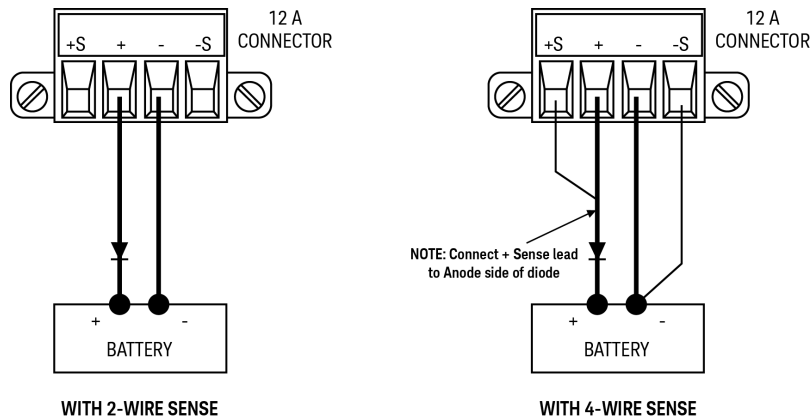
**OCP State**

With over-current protection enabled, the power supply disables the output if the output current reaches the current limit setting, which causes a transition from CV to CC mode.

Press **OCP State On** to enable over-current protection.

Press **OCP State Off** to disable over-current protection.

**NOTE**

You can also specify a delay to prevent momentary CV-to-CC status changes from tripping the OCP. The delay can be programmed from 0 to 3600 seconds. You can specify if the start of the delay is initiated by any transition into CC mode, or only at the end of a settings change in voltage, current or output state.

**OCP Delay**

The power supply may momentarily cross into CC mode when it is turned on, when an output value is programmed, or when the output load is connected. In most cases these temporary conditions would not be considered an over-current protection fault, and having an OCP condition disables the output when the CC status bit is set would be a nuisance. Specifying an OCP delay will ignore the CC status bit during the specified delay period.

To set the over-current protection delay, enter the delay value in the OC Protection Delay field. The delay can be programmed from 0 to 3600 seconds.

**OCP Delay Start**

Specifying an OCP Delay Start lets the OCP circuit ignore the CC status bit during the specified delay period. Once the OCP delay time has expired and if the CC mode persists, the output will shut down.

You can specify the OCP delay start timer through:

- CC Transition: delay timer start at any transition of the output into CC mode. Press **OCP Start CC**.

– Setting Change: delay timer start at the end of a settings change in voltage, current, or output state. Press **OCP Start Set**.

### Clears and OVP and OCP Event

To clear the protection function, first remove that condition that caused the protection fault.

Press **Protection Clear** to clear the protection function and returns the output to its previous operating state.

#### **From the remote interface:**

To set the over-voltage protection for output 1 to the maximum limit:

```
VOLT:PROT MAX (@1)
```

To enable the over-current protection for output 1 and 3:

```
CURR:PROT:STAT ON (@1,3)
```

To set the over-current protection delay time for output 1 at 3 seconds:

```
CURR:PROT:DEL 3 (@1)
```

To set the over-current protection delay timer start for output 1 to CC transition:

```
CURR:PROT:DEL:STAR CCTR (@1)
```

To clear protection for output 1:

```
OUTP:PROT:CLE (@1)
```

## Specifying 2-Wire or 4-Wire Sense (E36312A and E36313A Only)

### NOTE

When 4w mode is selected, ensure the load is connected to the rear panel output for accurate reading.

### CAUTION

DO NOT USE both front and rear panel output concurrently. This may lead to inaccurate output reading.

You have the option to use the remote sense terminals on the rear panel to measure the voltage at the device under test (DUT).

1. Press **Source Settings**.
2. Press **Sense 2w** or **Sense 4w** to select 2-wire sense or 4-wire sense.
3. Press **Back** to exit and return to the meter-view display.

The 2w mode closes a relay within the power supply to short the output and sense connectors. This means that only two wires are used, and 4-wire sense is disabled. The 4w mode opens the relay in order to separate the output and 4-wire sense inputs. By default, 2w is selected.

### From the remote interface:

To set the remote sense relay to 4-wire sense at output 3:

```
VOLT:SENS EXT (@3)
```

## Using the Tracking Operation

The E36300 Series provides 0 to  $\pm 25$  V tracking outputs. In the track mode, two voltages from Output 2 and Output 3 track each other for convenience in varying the symmetrical voltages needed by operational amplifiers and other circuits using balanced positive and negative inputs. The state of the track mode is stored in volatile memory. The track mode is always in off state even when power is being disconnected or after a remote interface reset.

1. Set Output 2 to your desired voltage.
2. Press **[Tracking]** to enable track mode. You can also enable the track mode by pressing **Output Settings > Operation Mode > Mode Tracking**.

When track mode is enabled, Output 3 will be set to the same voltage level as the Output 2 and vice versa. The current limit is independently set for each of the outputs and is not affected by the track mode.

3. Verify that both Output 2 and 3 track each other properly.  
You can verify from the front-panel display by comparing the voltage values of Output 2 and Output 3.

### NOTE

In the track mode, if the CC annunciator is lit when the display is selected for the +25 V supply, choose a higher current limit for the +25 V supply. If the CC annunciator is lit when the display is selected for the -25 V supply, choose a higher current limit for the -25 V supply.

---

Ensure the track mode is disabled when couple trigger is enabled (INSTrument:COUPle) in E3631A mode.

---

### From the remote interface:

To enable track mode:

```
OUTP:TRAC ON
```



## Configuring the Output Turn On Turn Off Sequence (E36312A and E36313A Only)

Turn-on and turn-off delays control the turn-on and turn-off timing of the outputs in relation to each other.

Step 1 – Set the output voltage and current of the output channels:

Refer to steps 1 and 2 under **Controlling the Outputs** and set the output voltage and current values of all outputs that will be sequenced.

Step 2 – Configure the turn-on turn-off delays:

Press **Output Settings** to access the Output Settings – On/Off Delays. Enter the On Delays and Off Delays for all outputs that will participate in the output on/off delay sequence. Values can range from 0 to 3600 seconds.

Output	On Delays	Off Delays	On/Off Coupling
1	0.000 s	0.000 s	1 On 2 Off 3 Off
2	0.000 s	0.000 s	
3	0.000 s	0.000 s	

Output Inhibit: Off

Operation Mode: Independent

Navigation: On/Off Coupling, Output Inhibit, Operation Mode, Back

Step 3 – Coupling selected outputs:

### NOTE

This step is only required if you will be including some outputs to participate in an output on/off delay sequence or if you are coupling multiple power supplies. If only a single output is to be used in the sequence, you can skip this step.

From the menu, press **On/Off Coupling** to access the On/Off Coupling mode settings.

- Press **Coup CH 1** to toggle between Off and On in order to turn off or on the coupling for Output 1.
- Press **Coup CH 2** to toggle between Off and On in order to turn off or on the coupling for Output 2.
- Press **Coup CH 3** to toggle between Off and On in order to turn off or on the coupling for Output 3.

**Output Settings - On/Off Coupling**

Output	On Delays	Off Delays	On/Off Coupling
1	0.000 s	0.000 s	1 On 2 Off 3 Off
2	0.000 s	0.000 s	
3	0.000 s	0.000 s	

**Output Inhibit**  
Off

**Operation Mode**  
Independent

Coup CH1: Off On  
Coup CH2: Off On  
Coup CH3: Off On  
Back

Step 4 – Use the All Outputs On and Off keys:

Once output delays have been set, press [All On/Off] to start the On delay and Off delay sequence.

**NOTE** [All On/Off] will turn ALL outputs on or off, whether they are configured to participate in an output on/off delay sequence or not.

#### From the remote interface:

To program turn-on and turn-off delays for outputs 1 through 3:

```

OUTP:DEL:RISE 0.01,(@1)
OUTP:DEL:RISE 0.02,(@2)
OUTP:DEL:RISE 0.03,(@3)
OUTP:DEL:FALL 0.04,(@1)
OUTP:DEL:FALL 0.03,(@2)
OUTP:DEL:FALL 0.02,(@3)

```

To only include outputs 1 and 2 in a sequence :

```

OUTP:COUP:CHAN CH1,CH2

```

To turn on two coupled outputs in a sequence:

```

OUTP ON (@1:2)

```

## Specifying the Operation Mode (E36312A and E36313A Only)

### NOTE

DO NOT use Coupling mode and Tracking mode when Auto-Series or Auto-Parallel mode is selected.

The Operation Mode allows you to specify the output capability when two independent outputs are being used.

- Independent: This operation supply two independent outputs capability to a maximum rating of +25 V, 1 A (E36312A) and +25 V, 2 A (E36313A). In Independent mode, the instrument is at its default output state.
- Auto-Series: This operation increase the output voltage capability to a maximum rating of +50 V, 1 A (E36312A) and +50 V, 2 A (E36313A). In Auto-Series mode, the instrument doubles the voltage across Output 2 and Output 3, but Output 3 no longer operates. .
- Auto-Parallel: This operation increase the current capability to a maximum rating of +25 V, 2 A (E36312A) and +25 V, 4 A (E36313A). In Auto-Parallel mode, the instrument doubles the output current on Output 2, but Output 3 no longer operates.
- Tracking: This operation tracks the voltage for Output 2 and Output 3. See [Using the Tracking Operation](#) for details.

1. Press **Source Settings > Operation Mode**.
2. Press **Independent, Series, Parallel** or **Tracking** to select the desired operation mode.



3. Press **Back** to exit.

For output connection in Auto-Series and Auto-Parallel mode, see [Parallel and Series Connections](#) for details.

### From the remote interface:

To enable Auto-Series mode:

```
OUT:PAIR SER
```

To enable Auto-Parallel mode:

```
OUT:PAIR PAR
```

To enable Tracking mode:

```
OUTP:TRAC ON
```

## Using the Digital Control Port (E36312A and E36313A Only)

### Bi-directional digital IO

#### Digital input

#### Fault output

#### Inhibit input

#### Fault/inhibit system protection

#### Trigger input

#### Trigger output

### Output Couple Controls

A Digital Control Port consisting of three I/O pins is provided to access various control functions. Each pin is user-configurable. The following control functions are available for the I/O pins:

### Bi-directional digital IO

Each of the three pins can be configured as general purpose bi-directional digital inputs and outputs. The polarity of the pins can also be configured. Pin 4 is the signal common for the digital I/O pins. Data is programmed according to the following bit assignments:

Pins	3	2	1
Bit Weight	2 (msb)	1	0 (lsb)

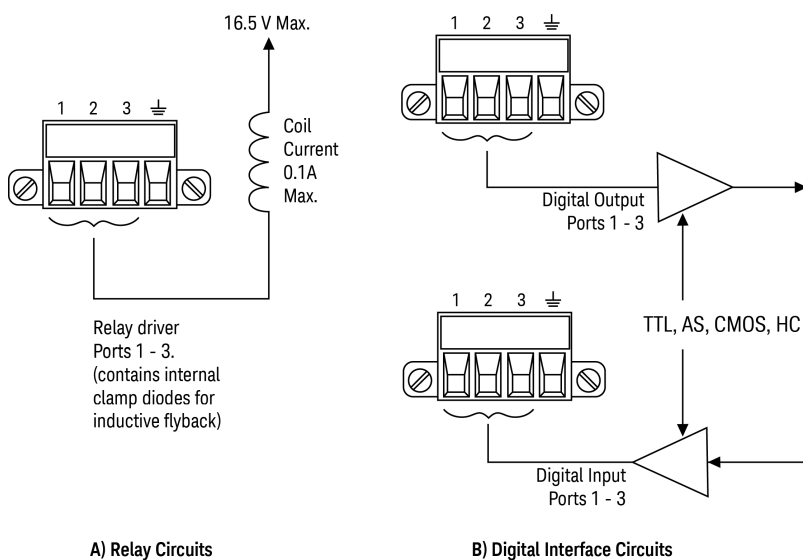

The digital I/O pin can be used to control both relay circuits as well as digital interface circuits. The figure above illustrates typical relay circuits as well as digital interface circuit connections using the digital I/O functions.

### From the front panel:

1. Press **Utilities** > **I/O Config** > **Digital IO** to access the Digital I/O window.

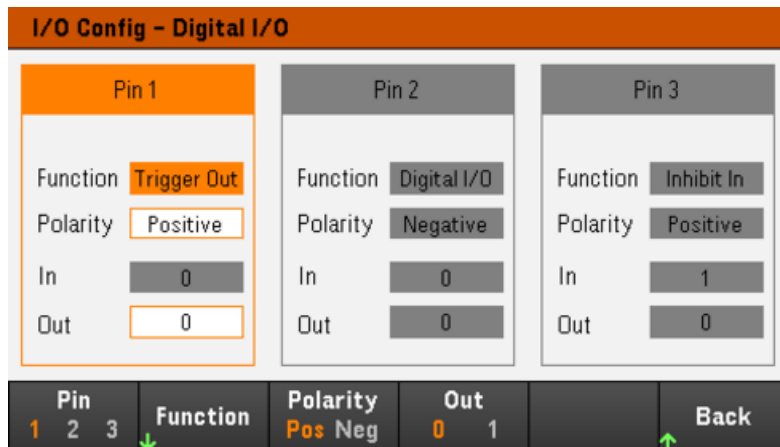

2. Select the pin you wish to configure. For example, press **Pin 1** to configure Pin 1.

3. Press **Function** and select **Digital I/O**. Select and program the remaining pins in the same manner. Press **Back** to return to previous page.

4. Configure the polarity for each of the pin. Press **Polarity Pos** to select Positive and **Polarity Neg** to select Negative. Select and program the remaining pins in the same manner.

5. The In and Out field only apply to the Digital I/O and Digital In functions. Press **Out** to toggle and enter the binary bit (0 or 1) into the Out field of the digital I/O window. For Digital I/O function, a binary bit 1 with positive polarity specify a voltage high at the pin while a binary bit 0 with positive polarity specify a voltage low at the pin. The In field reflects the condition of the external signal that is applied to the pins.

### From the remote interface:

To configure the digital I/O function for pins 1 through 3:

```
DIG:PIN1:FUNC DIO
DIG:PIN2:FUNC DIO
DIG:PIN3:FUNC DIO
```

To configure the pin polarity to positive for pins 1 through 3:

```
DIG:PIN1:POL POS
DIG:PIN2:POL POS
DIG:PIN3:POL POS
```

To send a binary weighted value to configure pins 1 through 3 as "111":

```
DIG:OUTP:DATA 7
```

## Digital input

Each of the three pins can be configured as digital input only. The ground reference for the input pins is Signal Common on pin 4.

### From the front panel:

1. Press **Utilities** > **I/O Config** > **Digital IO** to access the Digital I/O window.
2. Select the pin you wish to configure. For example, press **Pin 1** to configure Pin 1.
3. Press **Function** and select **Digital In**. Select and program the remaining pins in the same manner. Press **Back** to return to previous page.
4. Configure the polarity for each of the pin. Press **Polarity Pos** to select Positive and **Polarity Neg** to select Negative. Select and program the remaining pins in the same manner.
5. The In and Out field only apply to the Digital I/O and Digital In functions. The In field reflects the condition of the external signal that is applied to the pins. The pin state is not affected by the value of the binary output word.

### From the remote interface:

To configure the pin function:

```
DIG:PIN1:FUNC DINP
```

To select the pin polarity:

```
DIG:PIN1:POL POS
```

```
DIG:PIN1:POL NEG
```

To read the pin data:

```
DIG:INP:DATA?
```

## Fault output

Pins 1 and 2 can be configured as a fault output. The Fault Output function enables a fault condition on any channel to generate a protection fault signal on the digital port. The following conditions will generate a fault event: over-voltage, over-current, over-temperature and inhibit signal.

Both pins 1 and 2 are dedicated to this function. Pin 1 is the fault output; pin 2 is the common for pin 1. This provides for an optically-isolated output. The polarity of pin 1 can also be configured. Note that the fault output signal remains latched until the fault condition is removed and the protection circuit is cleared.

### NOTE

Pin 2's selected function is ignored. Pin 2 should be connected to the ground of the external circuit.

---

### From the front panel:

1. Press **Utilities** > **I/O Config** > **Digital IO** to access the Digital I/O window.
2. Press **Pin 1** to configure Pin 1.
3. Press **Function** and select **Fault Out**. Press **Back** to return to previous page.
4. Configure the polarity for each of the pin. Press **Polarity Pos** to select Positive and **Polarity Neg** to select Negative.

### From the remote interface:

To configure the pin function:

```
DIG:PIN1:FUNC FAUL
```

To select the pin polarity:

```
DIG:PIN1:POL POS
```

```
DIG:PIN1:POL NEG
```

### Inhibit input

Pin 3 can be configured as a remote inhibit input. The Inhibit Input function lets an external input signal control the output state of all the output channels in the power supply. The polarity of pin 3 can also be configured. The input is level triggered. The signal latency is less than 450 microseconds. Maximum time required for all the output channels to start to turn off is 45 ms. Pin 4 is the common for pin 3.

The following non-volatile inhibit input modes can be programmed:

**LATChing** - causes a logic-true transition on the Inhibit input to disable the output. The output will remain disabled after the inhibit signal is received.

**LIVE** - allows the enabled output to follow the state of the Inhibit input. When the Inhibit input is true, the output is disabled. When the Inhibit input is false, the output is re-enabled.

**OFF** - The Inhibit input is ignored.

### From the front panel:

#### Configure Pin 3 as a remote inhibit input:

1. Press **Utilities** > **I/O Config** > **Digital IO** to access the Digital I/O window.
2. Press **Pin 3** to configure Pin 3.
3. Press **Function** and select **Inhibit In** to configure Pin 3 as a remote inhibit input. Press **Back** to return to previous page.
4. Configure the polarity for Pin 3. Press **Polarity Pos** to select Positive and **Polarity Neg** to select Negative.

Alternatively, you can configure Pin 3 as a remote inhibit input by pressing **Output Settings** > **Output Inhibit** > **DIO Pin 3 INH**. In this setting, the polarity is set to Positive by default.

## Configure the inhibit input mode:

1. Press the **Output Settings** > **Output Inhibit** to configure the inhibit input mode.
2. Select the desired mode (**Off**, **Latched** or **Live**).



To clear the Inhibit protection function, first remove the external Inhibit signal. Then select **Source Settings** > **Protection Clear** for all outputs. This clears the Inhibit protection function and returns the output to its previous operating state.

## From the remote interface:

To select the Inhibit function:

```
DIG:PIN3:FUNC INH
```

To select the pin polarity:

```
DIG:PIN3:POL POS
```

```
DIG:PIN3:POL NEG
```

To set Inhibit mode to Latching:

```
OUTP:INH:MODE LATC
```

To set Inhibit mode to Live:

```
OUTP:INH:MODE LIVE
```

To disable the Inhibit signal:

```
OUTP:INH:MODE OFF
```

## Fault/inhibit system protection

The following figure illustrates some ways that you can connect the Fault/Inhibit pins of the connector.

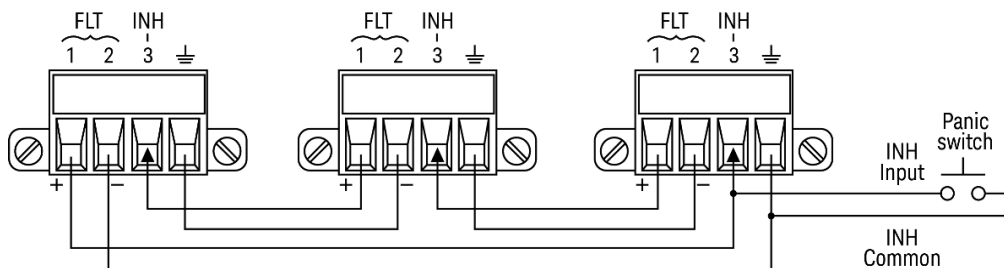

As shown in the figure, when the Fault outputs and Inhibit inputs of several instruments are daisy-chained, an internal fault condition in one of the units will disable all outputs without intervention by either the controller or external circuitry. Note that when using the Fault/Inhibit signals in this manner, both signals must be set to the same polarity.



You can also connect the Inhibit input to a manual switch or external control signal that will short the Inhibit pin to common whenever it is necessary to disable all outputs. **Negative** polarity must be programmed for all pins in this case. You can also use the Fault output to drive an external relay circuit or signal other devices whenever a user-definable fault occurs.

### Clearing a System Protection Fault

To restore all instruments to a normal operating condition when a fault condition occurs in a daisy-chained system protection configuration, two fault conditions must be removed:

1. The initial protection fault or external Inhibit signal.
2. The subsequent daisy-chained fault signal (which is sourced by the Inhibit signal).

#### NOTE

Even when the initial fault condition or external signal is removed, the fault signal is still active and will continue to shut down the outputs of all the units.

To clear the daisy-chained fault signal if the operating mode of the Inhibit input is Live, simply clear the output protection on any ONE unit by pressing **Source Settings > Protection Clear** for all outputs.

If the operating mode of the Inhibit input is Latched, turn off the inhibit input and clear the output protection for all outputs on ALL units individually. To re-enable the chain, re-program the Inhibit input on each unit to Latched mode.

### Trigger input

Any of the Digital Control pins can be programmed to function as a trigger input. All pins are referenced to the signal common pin.

To input an external trigger signal, you can apply either a negative-going or a positive-going pulse to the designated trigger input pin. The trigger latency is less than 450 microseconds. The minimum pulse width is 2 microseconds. The pin's polarity setting determines which edge generates a trigger-in event. Positive means a rising edge and Negative means a falling edge.

You can configure the data logger and the output list to be triggered by external trigger signals. Simply select DIO Trigger In as the trigger source when configuring the data logger and output list. This will enable input trigger signals on the configured digital pins. A trigger is generated when an external signal that meets the signal criteria is applied to any configured trigger input pin.

#### From the front panel:

1. Press **Utilities > I/O Config > Digital IO** to access the Digital I/O window.
2. Select the pin you wish to configure. For example, press **Pin 1** to configure Pin 1.
3. Press **Function** and select **Trigger In**. Select and program the remaining pins in the same manner. Press **Back** to return to previous page.
4. Configure the polarity for each of the pin. Press **Polarity Pos** to select Positive and **Polarity Neg** to select Negative. Select and program the remaining pins in the same manner.

### From the remote interface:

To select the trigger input function:

DIG:PIN1:FUNC TINP

To select the pin polarity:

DIG:PIN1:POL POS

DIG:PIN1:POL NEG

### Trigger output

Any of the Digital Control pins can be programmed to function as a trigger output. All pins are referenced to the Signal Common pin.

When configured as a trigger output, the designated trigger pin will generate a 10-microsecond trigger pulse in response to a trigger event. The polarity setting can be either positive-going (rising edge) or negative-going (falling edge) when referenced to common.

Trigger out signals can be generated when configuring the voltage and current in the Output LIST. If you check the BOST and EOST boxes when configuring the Output LIST, an output trigger signal will be generated on the configured digital pin at the start and end of the voltage and current step.

### From the front panel:

1. Press **Utilities** > **I/O Config** > **Digital IO** to access the Digital I/O window.
2. Select the pin you wish to configure. For example, press **Pin 1** to configure Pin 1.
3. Press **Function** and select **Trigger Out**. Select and program the remaining pins in the same manner. Press **Back** to return to previous page.
4. Configure the polarity for each of the pin. Press **Polarity Pos** to select Positive and **Polarity Neg** to select Negative. Select and program the remaining pins in the same manner.

### From the remote interface:

To select the trigger output function:

DIG:PIN1:FUNC TOUT

To select the pin polarity:

DIG:PIN1:POL POS

DIG:PIN1:POL NEG

### Output couple controls

This function lets you connect multiple Keysight E36300 Series power supplies together and synchronize the output on/off sequence across units. Each power supply that will be synchronized must have at least one coupled output.

1. Configure the outputs on each power supply as described under **Configuring the Output Turn-On/Turn-Off Sequence**. Set the output coupling mode to ON.
2. Set the delay offset of each individual unit to match the longest delay offset of the power supply group.
3. Connect and configure the digital connector pins of the synchronized power supplies as described in this section.

**NOTE**

All synchronized E36300 Series power supplies must have the same firmware revision. Only pins 1 through 3 can be configured as synchronization pins. You cannot configure more than one On Couple and one Off Couple pin per power supply. The polarity of the pins is not programmable; it is set to Negative.

The digital connector pins of the synchronized power supplies that contain coupled outputs must be connected together as shown in the following figure. In this example, pin 2 will be configured as the output On control. Pin 3 will be configured as the output Off control. The ground or Common pins also need to be connected together.

Only two of the digital connector pins on each power supply can be configured as “On Couple” and “Off Couple” on each synchronized power supply. The designated pins will function as both an input and an output, with a negative transition on one pin providing the synchronization signal to the other pins.

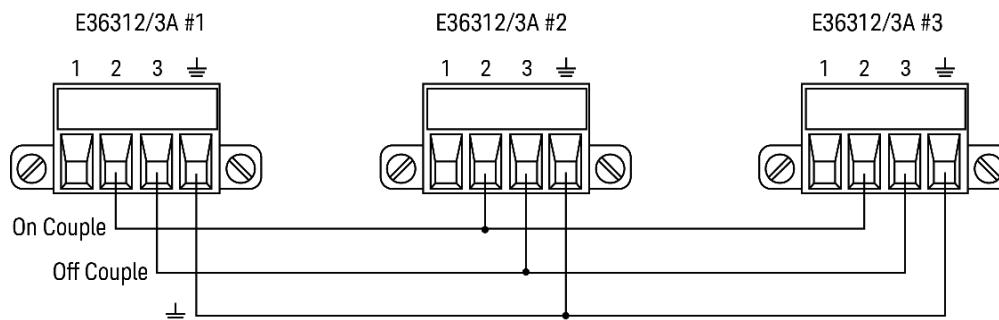

**From the front panel:**

1. Press **Utilities** > **I/O Config** > **Digital IO** to access the Digital I/O window.
2. Press **Pin 2**. Press **Function** and select **Couple On**.
3. Press **Pin 3**. Press **Function** and select **Couple Off**.
4. Repeat these steps for power supply #2 and #3.

**From the remote interface:**

To configure pin 2 of power supply #1 as the ON control:

DIG:PIN2:FUNC ONC

To configure pin 3 of power supply #1 as the OFF control:

DIG:PIN3:FUNC OFFC

Repeat these commands for power supply #2 and #3.

## Operation

Once configured and enabled, turning the output on or off on any coupled output will cause all coupled outputs on all configured power supplies to turn on or off according to their user-programmed delays. This applies to the front panel On and Off keys, the Web server, and to SCPI commands.

Turning the outputs on or off using the front panel **[All On/Off]** key will cause all coupled outputs as well as non-coupled outputs on that power supply to turn on or off.

## Using the Output LIST (E36312A and E36313A Only)

The Output LIST allows single or multiple outputs to run in sequence. You can set the followings for each of the output in sequence.

1. Set the step that will generate the trigger out signal at the beginning/end of the step.
2. Set the last output value after the sequence list completes.
3. Set how the list responds to triggers.
4. Set the transient mode for voltage and current.
5. Set the trigger source for the transient system.
6. Set the trigger delay in seconds.
7. Set the list repeat count.
8. Set the list to repeat continuously.

You can configure up to 100 voltage and current steps in the Output LIST window.

### Step 1 – Add/remove steps to/from the LIST

Press **Output LIST** to access the Output LIST window.

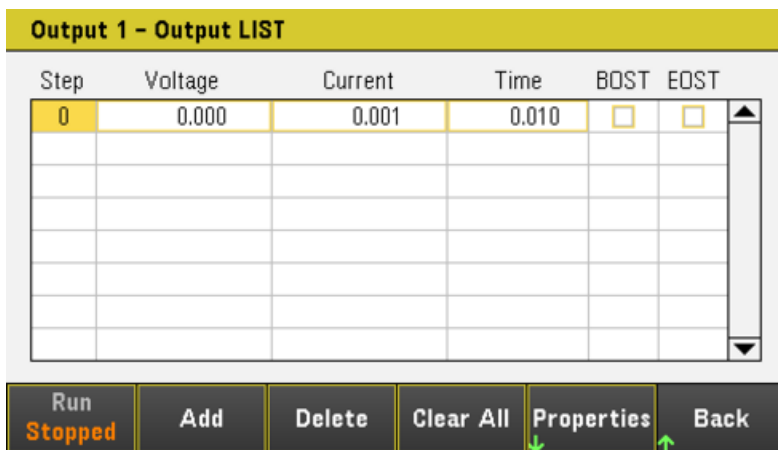

Step	Voltage	Current	Time	BOST	EOST
0	0.000	0.001	0.010	<input type="checkbox"/>	<input type="checkbox"/>

Run Stopped   Add   Delete   Clear All   Properties   Back

Press **Add** to insert a new step below the selected step. Note that the values in the new step are copied from the previous step. Continue to add steps until your sequence is complete. Use the navigation keys to move through the list.

Press **Delete** if you want to delete the selected step or press **Clear All** if you want to remove all steps from the list.

## Step 2 – Configure the output sequence

Configure the Voltage, Current, Time, BOST and EOST accordingly. Use the navigation keys to select the field; use the numeric entry keys to enter the value. The value is set when you press **[Enter]**.

Output 1 – Output LIST					
Step	Voltage	Current	Time	BOST	EOST
0	0.000	0.001	0.010	<input type="checkbox"/>	<input type="checkbox"/>
1	2.000	0.500	2.000	<input checked="" type="checkbox"/>	<input type="checkbox"/>
2	2.800	0.500	3.000	<input checked="" type="checkbox"/>	<input checked="" type="checkbox"/>

Run Stopped	Add	Delete	Clear All	Properties	Back
----------------	-----	--------	-----------	------------	------

Fields	Description
Voltage	Sets the voltage value for selected step in voltage.
Current	Sets the current value for selected step in ampere.
Time	Sets the run-time for selected step in seconds.
BOST	Enables check box to set which step will generate a trigger-out signal at the beginning of the step (BOST).
EOST	Enables check box to set which step will generate a trigger-out signal at the end of the step (EOST).

For additional settings, press **Properties** to open the Output LIST Properties window. Configure the Output LIST accordingly. Refer to the below table for details.

Output 1 – Output LIST Properties	
Voltage/Current After List	Return to DC Value
Pace	Dwell
Voltage Mode	Fixed
Current Mode	Fixed
Trigger Source	Remote Command
Trigger Delay	0.000
Repeat Count	1 <input type="checkbox"/> Continuous

V/I List DC List	Pace Dwl Trg	V Mode Fix Stp Lst	I Mode Fix Stp Lst	Trig Src Key IO Rmt	Back
---------------------	-----------------	-----------------------	-----------------------	------------------------	------

Settings	Available Key Settings	Description				
Voltage /Current After List	DC or List	Specifies what happens when the output sequence completes. Default is DC.				
		<p><u>Action required:</u> Press <b>V/I List</b> to toggle between DC and List.</p>				
		<table border="1"> <tr> <td><b>DC</b> (Return to DC Value)</td> <td>Returns to the DC value that was in effect before the output sequence started.</td> </tr> <tr> <td><b>List</b> (Last List Value)</td> <td>Remains at the last list value.</td> </tr> </table>	<b>DC</b> (Return to DC Value)	Returns to the DC value that was in effect before the output sequence started.	<b>List</b> (Last List Value)	Remains at the last list value.
<b>DC</b> (Return to DC Value)	Returns to the DC value that was in effect before the output sequence started.					
<b>List</b> (Last List Value)	Remains at the last list value.					
Pace	Dwl or Trg	Configures the pacing of the step. Default is Dwl.				
		<p><u>Action required:</u> Press <b>Pace</b> to toggle between Dwl and Trg.</p>				
		<table border="1"> <tr> <td><b>Dwl</b> (Dwell)</td> <td>The next step immediately outputs when the dwell time has elapsed.</td> </tr> <tr> <td><b>Trg</b> (Trigger)</td> <td>The next step immediately outputs when an external trigger is received. If the step time completes before trigger occurs, the step remains at the last list value while waiting for the trigger.</td> </tr> </table>	<b>Dwl</b> (Dwell)	The next step immediately outputs when the dwell time has elapsed.	<b>Trg</b> (Trigger)	The next step immediately outputs when an external trigger is received. If the step time completes before trigger occurs, the step remains at the last list value while waiting for the trigger.
<b>Dwl</b> (Dwell)	The next step immediately outputs when the dwell time has elapsed.					
<b>Trg</b> (Trigger)	The next step immediately outputs when an external trigger is received. If the step time completes before trigger occurs, the step remains at the last list value while waiting for the trigger.					
Voltage Mode	Fix, Stp or Lst	Sets the voltage mode. This determines what happens to the output voltage when the system is initiated or triggered. Default is Fix				
		Note: If current mode is set to Step, voltage mode is not allowed to set to List and vice versa.				
		<p><u>Action required:</u> Press <b>V Mode</b> to toggle between Fix, Stp and Lst.</p> <table border="1"> <tr> <td><b>Fix</b> (Fixed)</td> <td>Keeps the output at its immediate value.</td> </tr> <tr> <td><b>Stp</b> (Step)</td> <td>Steps the output to the triggered level when a trigger occurs</td> </tr> <tr> <td><b>Lst</b> (List)</td> <td>Causes the output to follow the list values when a trigger occurs.</td> </tr> </table>	<b>Fix</b> (Fixed)	Keeps the output at its immediate value.	<b>Stp</b> (Step)	Steps the output to the triggered level when a trigger occurs
<b>Fix</b> (Fixed)	Keeps the output at its immediate value.					
<b>Stp</b> (Step)	Steps the output to the triggered level when a trigger occurs					
<b>Lst</b> (List)	Causes the output to follow the list values when a trigger occurs.					
Current Mode	Fix, Stp or Lst	Sets the current mode. This determines what happens to the output current when the system is initiated or triggered. Default is Fix				
		Note: If voltage mode is set to Step, current mode is not allowed to set to List and vice versa.				
		<p><u>Action required:</u> Press <b>I Mode</b> to toggle between Fix, Stp and Lst.</p> <table border="1"> <tr> <td><b>Fix</b> (Fixed)</td> <td>Keeps the output at its immediate value.</td> </tr> <tr> <td><b>Stp</b> (Step)</td> <td>Steps the output to the triggered level when a trigger occurs</td> </tr> <tr> <td><b>Lst</b> (List)</td> <td>Causes the output to follow the list values when a trigger occurs.</td> </tr> </table>	<b>Fix</b> (Fixed)	Keeps the output at its immediate value.	<b>Stp</b> (Step)	Steps the output to the triggered level when a trigger occurs
<b>Fix</b> (Fixed)	Keeps the output at its immediate value.					
<b>Stp</b> (Step)	Steps the output to the triggered level when a trigger occurs					
<b>Lst</b> (List)	Causes the output to follow the list values when a trigger occurs.					

Settings	Available Key Settings	Description						
Trigger Source	Key, IO or Rmt	<p>Sets the trigger source for the system. Default is Key.</p> <p><u>Action required:</u> Press <b>Trig Src</b> to toggle between Key, IO and Rmt.</p> <hr/> <table border="1"> <tr> <td><b>Key</b> (List Run/Stop Key)</td> <td>Selects the Run Stopped softkey as a trigger source.</td> </tr> <tr> <td><b>IO</b> (DIO Trigger In)</td> <td>Selects any configured digital IO (with Trigger Input function) as a trigger source</td> </tr> <tr> <td><b>Rmt</b> (Remote Command)</td> <td>Selects a remote interface command as a trigger source.</td> </tr> </table>	<b>Key</b> (List Run/Stop Key)	Selects the Run Stopped softkey as a trigger source.	<b>IO</b> (DIO Trigger In)	Selects any configured digital IO (with Trigger Input function) as a trigger source	<b>Rmt</b> (Remote Command)	Selects a remote interface command as a trigger source.
<b>Key</b> (List Run/Stop Key)	Selects the Run Stopped softkey as a trigger source.							
<b>IO</b> (DIO Trigger In)	Selects any configured digital IO (with Trigger Input function) as a trigger source							
<b>Rmt</b> (Remote Command)	Selects a remote interface command as a trigger source.							
Trigger Delay	0 to 3600 s	Sets the trigger delay in seconds. Default is 0 s.						
Repeat Count	1 to 256	Sets the list repeat count. This sets the number of times that a list is executed before it completes. Default is 1.						
Continuous	-	Enables check box to repeat the list continuously.						

### Step 3 – Run the output sequence list

#### NOTE

When Output LIST is initiated, all the List properties cannot be configured, which includes adding or removing step from the list.

When Step mode transient system is initiated, properties such as voltage mode, current mode, trigger source and trigger delay cannot be configured.

If both Voltage and Current Mode is set to Fix and Trigger Source is set to Key, pressing **Run** will automatically set both voltage and current mode to List and start the list operation.

- Set Voltage Mode to List: Press **V Mode Lst**.
- Set Current Mode to List: Press **I Mode Lst**.
- Set Trigger Source to Key. Press **Trig Src Key**.
- Press the color-coded **[On]** key to enable the selected output.
- Press **Run** to start the list operation. To abort the operation, press **Stopped**.
- Press **Back** to exit and return to the previous menu.



**From the remote interface:**

To configure the List voltage of output 1 with 1 V, 2 V, 3 V, 4 V and 5 V:

```
LIST:VOLT 1,2,3,4,5, (@1)
```

To configure the List current of output 1 with 0.1 A, 0.2 V, 0.3 A, 0.4 A and 0.5 A:

```
LIST:CURR 0.1,0.2,0.3,0.4,0.5, (@1)
```

To configure all the List time of output 1 with 1 s:

```
LIST:DWELL 1,1,1,1,1, (@1)
```

To enable all the List BOST of output 1:

```
LIST:TOUT:BOST 1,1,1,1,1, (@1)
```

To disable all the List EOST of output 1:

```
LIST:TOUT:EOST 0,0,0,0,0, (@1)
```

To set the voltage mode of output 1 to List:

```
VOLT:MODE LIST, (@1)
```

To set the current mode of output 1 to List:

```
CURR:MODE LIST, (@1)
```

To set the trigger source of output 1 to Key/Immediate:

```
TRIG:SOUR IMM, (@1)
```

To enable output 1:

```
OUTP ON, (@1)
```

To initiate and run the list:

```
INIT (@1)
```

## Using the Data Logger Function (E36312A and E36313A Only)

The Data Logger allows you to view and log output voltage and current data for up to 30,000 hours (for single output, depending on the memory size) and up to 7 MB of data.

You can configure the Data Logger View to display voltage or current waveforms for all outputs. Once data logging completes, the data is automatically stored to a file named default.dlog.

### NOTE

You must connect a USB drive to the front panel USB port when performing data log. You are not able to perform any data logging if a USB drive is not connected.

---

## Logging data

In the following data log example, a user-defined arbitrary waveform is captured on the data logger. The data logger records the actual output voltage of the arbitrary waveform.

### Step 1 – Program the sequence for the output channels

Configure the output sequence as described under [Using the Output LIST](#).

Program the output voltage and time values as follows:

Step 0: 1 V; 0.1 A; 1 s

Step 1: 2 V; 0.1 A; 1 s

Step 2: 3 V; 0.1 A; 1 s

Step 3: 4 V; 0.1 A; 1 s

Step 4: 5 V; 0.1 A; 1 s

Repeat Count: 5

Pace: Dwell

Voltage Mode: List

Current Mode: List

Trigger Source: List Run/Stop Key

Output 1 - Output LIST						
Step	Voltage	Current	Time	BOST	EOST	
0	1.000	0.100	1.000	<input type="checkbox"/>	<input type="checkbox"/>	▲
1	2.000	0.100	1.000	<input type="checkbox"/>	<input type="checkbox"/>	
2	3.000	0.100	1.000	<input type="checkbox"/>	<input type="checkbox"/>	
3	4.000	0.100	1.000	<input type="checkbox"/>	<input type="checkbox"/>	
4	5.000	0.100	1.000	<input type="checkbox"/>	<input type="checkbox"/>	

Run Stopped	Add	Delete	Clear All	Properties	Back
----------------	-----	--------	-----------	------------	------

Output 1 - Output LIST Properties	
Voltage/Current After List	Return to DC Value
Pace	Dwell
Voltage Mode	List
Current Mode	List
Trigger Source	List Run/Stop Key
Trigger Delay	0.000
Repeat Count	5 <input type="checkbox"/> Continuous

  

V/I List DC List	Pace Dwl Trg	V Mode Fix Stp Lst	I Mode Fix Stp Lst	Trig Src Key IO Rmt	Back
---------------------	-----------------	-----------------------	-----------------------	------------------------	------

### Step 2 – Configure the data logger traces

- Check V1. On the data logger display, use the navigation keys to select V1 and press **[Enter]**.
- Uncheck V2 and V3 as well as the current and power traces.
- Press **Waveform Settings > Vertical**. Use **Volts/Div –** or **Volts/Div +** to set V1 to 1V/Div. Use **Offset +** or **Offset –** to move the V1 trace to the bottom of the grid.

Traces are color coded according to output. The ground symbol on the right side of the display indicates the ground reference of the trace.

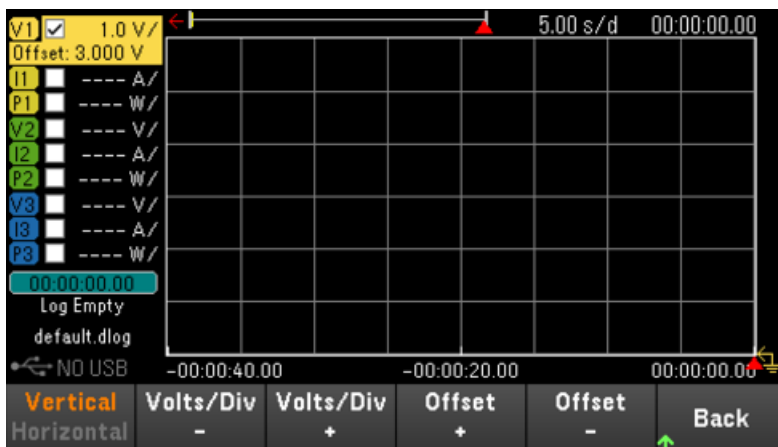

### Step 3 – Configure the data logger properties

Press **Logging** to display the Logging properties field.

- Leave the default Duration and Sample Period at 30 s and 200 ms respectively.
- Set the Trigger Source to Run/Stop Key by pressing **Trig Src Key**.

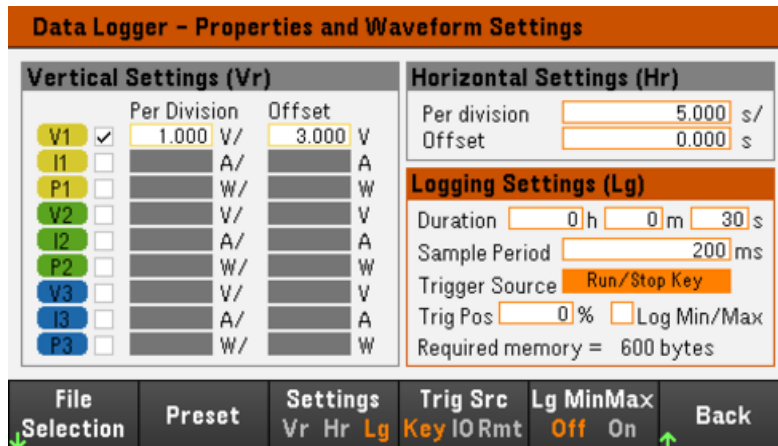

### Step 4 – Turn on Output 1, start the sequencing and log the data.

Press **Back** to return the display to the data logger view.

- Press Output 1 [**On**] to turn on Output 1.
- Press **Run Stopped** to run the data logger. The data logger will be initiated and Output 1 trace is displayed on the screen.
- Press **Output LIST > Run Stopped** to start output sequencing.

The data logger will run for 30 seconds and log the voltage data from output 1. When the data log completes, you should see the output waveform displayed as follows:

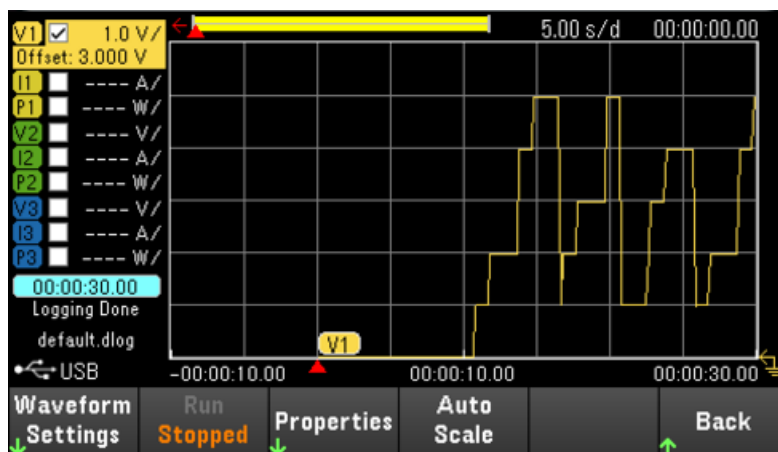

A message will indicate that the logged data has been saved in a file named default.dlog. If you wish to save the data under a different filename, you must specify the filename before the data logger runs.

Press **File Name** located at the data logger Properties menu to specify a filename.

## Step 5 – Export the data

After you have completed the data logging, you can use the **Export File** key to export the logged data to a .csv (comma separated values) file.

**Data Logger - Target File Selection**

Specify the file for the next data logger acquisition.

Save Path  
External:/

File Name  
default.dlog

Append date and time to file name.

Save Path   File Name   Export File   Load File   Back

When exporting the data, specify the output you want to export the logged data.

Press **Save Path** to browse and specify the location where the export file will be placed. Use the front-panel navigation keys to navigate through the list. The left and right arrows contract or expand a folder to hide or show its files. Press **Select** once you have specified the path or **Cancel** to abort the changes made.

Press **File Name** to configure the filename. Use the keyboard to enter your desired filename in the File Name field. Press **Back** to save or **Cancel** to abort the changes made.

Press **Export File** to export the file.

### From the remote interface:

To program output sequence of five steps on output 1:

```
LIST:VOLT 1,2,3,4,5, (@1)
```

```
LIST:CURR 0.1,0.1,0.1,0.1,0.1, (@1)
```

```
LIST:DWEL 1,1,1,1,1, (@1)
```

```
LIST:COUNT 5, (@1)
```

```
LIST:STEP AUTO, (@1)
```

```
VOLT:MODE LIST, (@1)
```

```
CURR:MODE LIST, (@1)
```

To initiate the trigger system:

```
TRIG:SOUR BUS
```

```
INIT (@1)
```

To set up the data log for output 1:

SENS:DLOG:FUNC:VOLT 1, (@1)

SENS:DLOG:TIME 30

SENS:DLOG:PER 0.2

To initiate that data logger and specify the filename in which to save the data:

TRIG:DLOG:SOUR BUS

INIT:DLOG "External:\log1.csv"

To turn on Output 1 and run the data logger:

OUTP ON, (@1)



\*TRG

### Data logger view

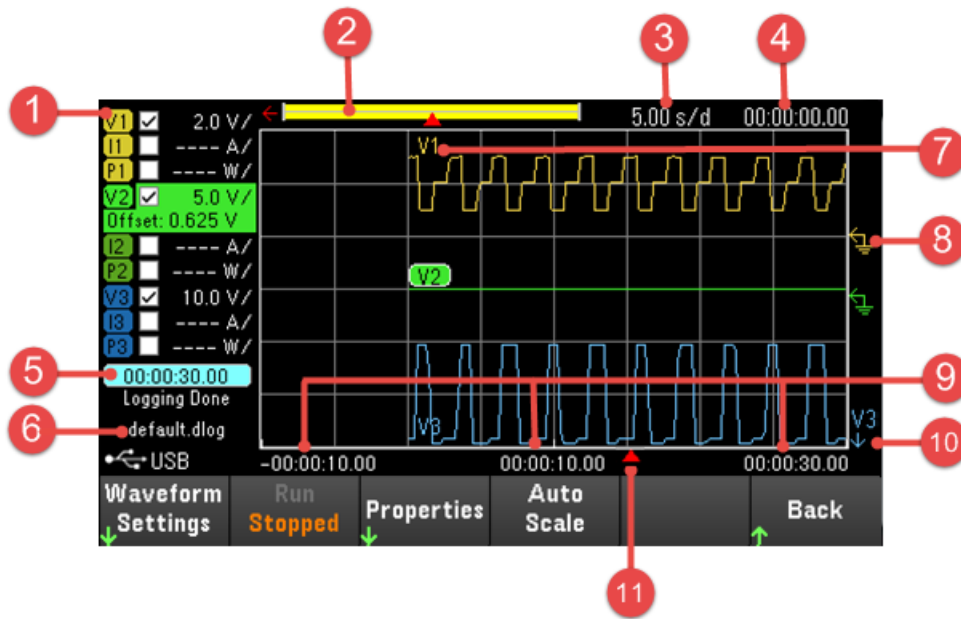
Press **Data Logger** to access the data logger.



Items	Description
1 Trace controls	Identifies the voltage or current trace that will be displayed. √ indicates the trace is on. Dashes (----) indicate the trace is off. Select the trace and press <b>[Enter]</b> to turn it on or off.
2 Data bar 	The data bar represents all of the logged data. The yellow part indicates the portion of the data that is visible on the display. The black part represents the data that is not visible.
3 Time/Div	Identifies the horizontal time-base setting. This can be adjusted using the Horizontal <b>Time/Div +</b> and <b>Time/Div -</b> in Waveform Settings.

Items	Description
4 Offset time	Indicates the time that the right gridline is offset or away from the end of the data log. When this value is zero, it means that the right gridline is positioned at the end of the data log. Adjusting the offset using the Horizontal <b>Offset +</b> and <b>Offset –</b> in Waveform Settings will move the grid away from the end of the data log, as indicated by the Offset Time.
5 Time elapsed	Indicates the time elapsed during the data log and the total duration. The values match when data logging finishes.
6 Filename	Indicates the filename of the data that is being logged.
7 Output traces	Voltage trace labels appear on the left side of the grid (V1 V2, V3) as shown in the display. Current trace labels appear on the right side of the grid (I1, I2, I3). Power trace labels appear on the center of the grid (P1, P2, P3). Press <b>Auto Scale</b> to auto-scale the data traces.
8  Ground reference	The ground reference of the trace. Ground references are offset so that they do not overlap. The ground reference offset value is referenced to the horizontal center line of the grid.
9 Grid time	Displays the time on the gridline.
10  Out of view arrows	Indicate that the trace, V3 in the figure, is out of view. Use the Vertical <b>Volts/Div +</b> and <b>Volts/Div –</b> or the Vertical <b>Offset +</b> and <b>Offset –</b> in Waveform Settings to bring the trace into view. Press <b>Auto Scale</b> to auto-scale the data traces.
11  Trigger point indicator	Indicates the trigger position in the data log. In this example the trigger point was offset by 50%, and the pre trigger and post trigger data was logged. The time at the trigger point is always zero. Change the trigger offset in the Data Logger Logging Settings.

Menu	Description
Waveform Settings	Sets the waveform display. See <a href="#">Adjusting the Waveform Display</a> .
Run Stopped	Run or stop data logging.
Properties	Sets the data logging and waveform displays properties. See <a href="#">Data Logger Properties and Waveform Settings</a> .
Auto Scale	Auto scales the traces on the display.

## Adjusting the waveform display

Press **Waveform Settings** to access the waveform settings menu. Press the first softkey to toggle between **Vertical** and **Horizontal** to display the vertical and horizontal settings menu. The Vertical settings menu will change accordingly to the selected trace.



Menu	Description
Volts/Div +/- Amps/Div +/- Watts/Div +/-	Makes the waveform bigger or smaller vertically in relation to its ground reference. Specified in volts/division, ampere/division and watts/division on the y axis.
Time/Div +/-	Stretches or shrinks the waveform horizontally around the horizontal offset reference. Specified in time/division on the x axis. Applies to ALL traces.
Vertical Offset +/-	Moves the ground reference of the trace up or down in relation to the horizontal center line of the grid.
Horizontal Offset +/-	Moves the waveform to the right or left of the horizontal offset reference.

### Data logger properties and waveform settings

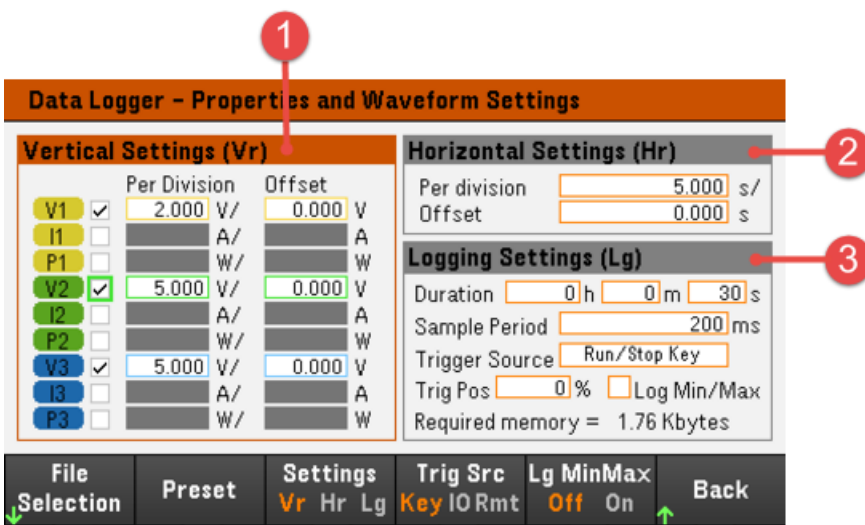

Items	Available settings	Description
1	Vertical Settings (Vr) Trace checkbox	Selects the trace to display for the output. If no checkbox is enabled, data logging will not be logged for the selected output. Configures the voltage/division, current/division, power/division and offsets for each output.
2	Horizontal Settings (Hr) Time/Division	Configures to zoom in or out of the data so that you can view waveform details. The numbers on the top of the display indicate the location of the data that is being viewed relative to the entire data log. Specified in time/division on the x axis. Applies to ALL traces.
	Offset	Configures the waveform location (right or left) of the horizontal offset reference. The trigger point is indicated by the solid arrow  .



Items	Available settings	Description
3 Logging (Lg)	Duration	Configures the duration of the data log in hours, minutes, and seconds. The maximum duration is 30,000 hours. The logging information applies to data logger measurements on all outputs.
	Sample Period	Configures the interval between data samples in milliseconds, which can be set from 200 milliseconds to 60 seconds.
	Trigger Source	Configures the trigger source for data logger.
	Trigger Pos	Trigger Position specifies a trigger offset. This allows the specified time of pretrigger data to be logged to the file. For example, if you specified a data log duration of 30 s and a trigger position of 50%, the Data Logger will log 15 s of pre-trigger data to the file before the trigger occurs. Subsequently, 15 s of post-trigger data will then be logged to the data file.
	Log Min/Max checkbox	When enabled, lets you log the minimum and maximum values of each sample to the data log file. With Log Min/Max checked, the resulting file size will triple.

Menu	Available settings	Description	
File Selection	-	Configures the file location and filename for logged data, export the file to .csv format and load the previously logged file to the instrument.	
Preset	-	Returns the Data Logger View to the power-on display settings.	
Settings	Vr, Hr or Lg	Selects the Vertical Settings, Horizontal Settings or Logging Settings field. <u>Action required:</u> Press <b>Settings</b> to toggle between Vr, Hr and Lg.	
Trig Src	Key, IO or Rmt	Configures the trigger source for data logger. Default is Key.  <u>Action required:</u> Press <b>Trig Src</b> to toggle between Key, IO and Rmt.	
		<b>Key</b> (List Run/Stop Key)	Selects the Run Stopped key as a trigger source.
		<b>IO</b> (DIO Trigger In)	Selects any configured digital IO (with Trigger Input function) as a trigger source.
		<b>Rmt</b> (Remote Command)	Selects a remote interface command as a trigger source.
Lg MinMax	Off or On	Sets to enable or disable the Log Min/Max checkbox. Enabling the checkbox will log the minimum and maximum values to the data log file. With Log Min/Max checked, the resulting file size will triple. Default is Off.  <u>Action required:</u> Press <b>Lg MinMax</b> to toggle between Off and On.	

### From the remote interface:

To enable current or voltage data logging on outputs 1 and 2:

```
SENS:DLOG:FUNC:CURR 1,(@1,2)
```

```
SENS:DLOG:FUNC:VOLT 1,(@1,2)
```

You cannot data log output power from the remote interface. To obtain power data, you need to data log both voltage and current and then calculate the power from the resulting voltage and current data.

To log the minimum and maximum values to the data log file for all enabled outputs:

```
SENS:DLOG:FUNC:MINM 1
```

To specify a data log of 1000 seconds on all enabled outputs:

```
SENS:DLOG:TIME 1000
```

To specify a sample period of 400 milliseconds between data samples on all enabled outputs:

```
SENS:DLOG:PER 0.4
```

To send an immediate trigger signal to the data logger:

```
TRIG:DLOG
```

To select the immediate trigger source (triggers the Data Logger immediately when initiated):

```
TRIG:DLOG:SOUR IMM
```

To select the rear panel trigger input (all connector pins that have been configured as trigger sources):

```
TRIG:DLOG:SOUR EXT
```

To select a BUS trigger source:

```
TRIG:DLOG:SOUR BUS
```

### Save the datalog

Press **File Selection** to specify a filename in which to save the datalog. Data will be logged to this filename the next time the Data Logger runs. If you do not specify a filename, the data will be logged to default.dlog, which is overwritten each time the Data Logger runs.

Enable the Append date and time to file name checkbox to include timestamp information on the filename.

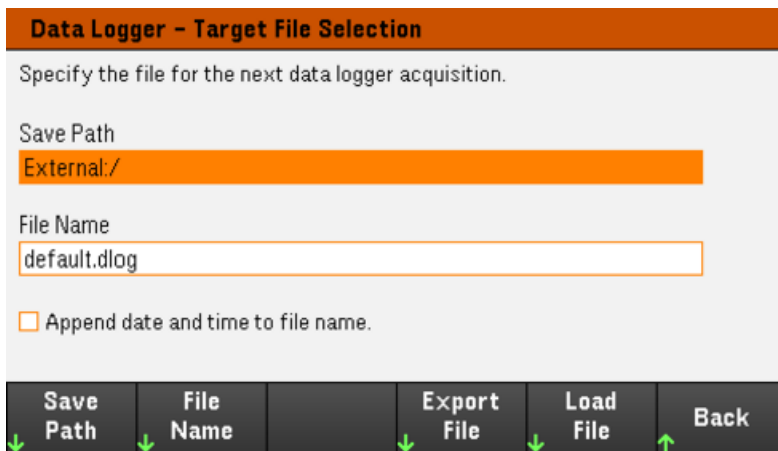

Press **Save Path** to browse and specify the location where the datalog will be saved. Use the front-panel navigation keys to navigate through the list. The left and right arrows contract or expand a folder to hide or show its files.

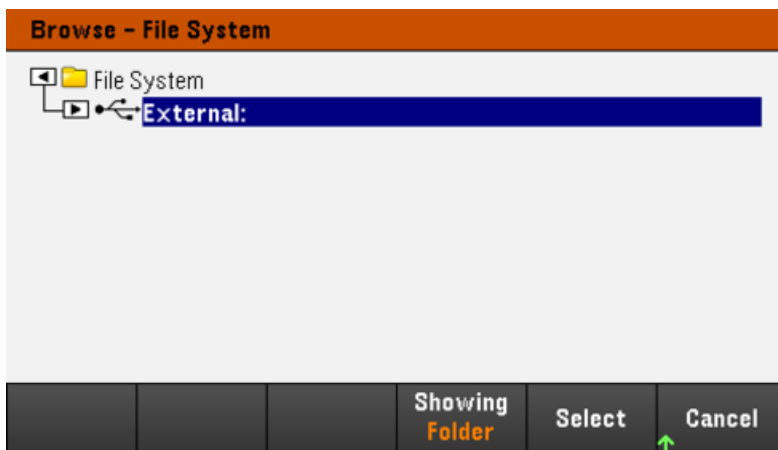

To view the available folder and files in the directory, press **Showing Folder** or **Showing All**. Press **Select** once you have specified the path or **Cancel** to abort.

Press **File Name** and use the keyboard to enter the filename in the File Name field. Press **Done** to save and **Cancel** to abort.

### Export the data

#### NOTE

To export a datalog that has been saved in the USB drive, you must first load the saved file into the data logger view.

Press **Export File** to export the data that is currently in the instrument's datalog viewer to file. The exported data is in .csv format.

For details on how to specify the save location and filename, refer to [Save the Data Log](#).

**Data Logger - Export Data**

Export the logged data to CSV file.

Save Path  
External:/

File Name

Save Path   File Name      Back

### Load the data

**NOTE** The file you load must be from same instrument model.

Press **Load File** to load the logged data to the instrument. You can load both binary files and data files in .csv format.

**Data Logger - Load File**

Please select the datalog file to be loaded.

Path

File

Browse      Back

Press **Browse** to browse and select file from the directory. Press **Select** to select the file or **Cancel** to abort.

Press **Load** to load the file.

## Locking/Unlocking the Front Panel

### NOTE

If you are in a menu, you must exit the menu before locking the front panel.

1. Press and hold **Lock|Unlock** to lock the front panel. This produces lock icon (🔒) in the upper corner of the display, as shown below.

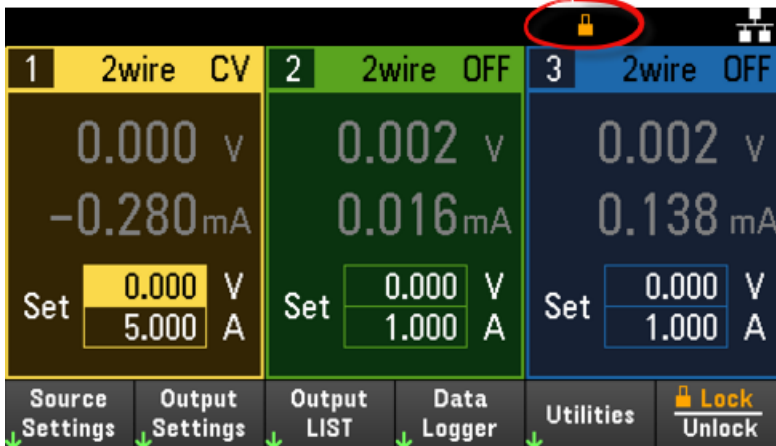

2. Press **[Lock|Unlock]** again to unlock the front panel.

### From the remote interface:

To lock all front panel keys including **Lock|Unlock** key:

```
SYST:RWL
```

To lock all front panel keys except **Lock|Unlock** key:

```
SYST:REM
```

To unlock the front panel:

```
SYST:LOC
```

## Capturing a Screen

Press **[Meter View]** for more than three seconds to capture a screen. The screen that was active will be saved to the USB flash storage connected to the front USB port.

To configure the screen capture storing path, refer to [Utilities Menu - Manage Files](#) for details.

## Enabling the E3631A Mode

The E3631A mode allows you to change the programmatic identity of the E36300 Series back to E3631A for code compatibility and enables it to work like the E3631A in existing applications.

Press **Utilities** > **Test / Setup** > **User Settings** > **SCPI ID**.

Press to select **SCPI ID E3631A** to enable the E3631A mode.

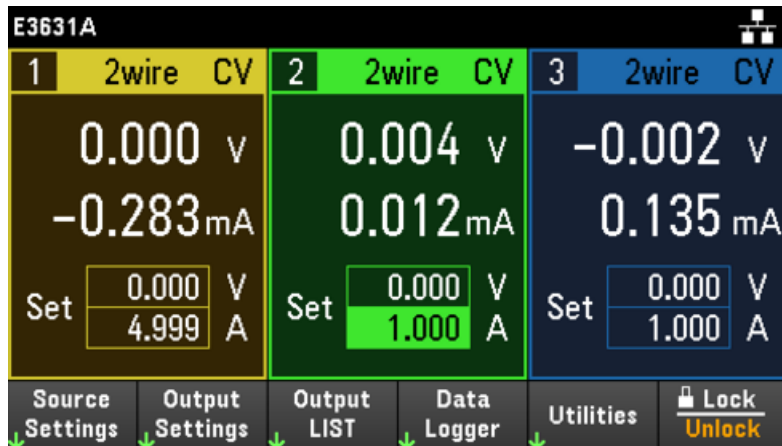

Once you entered this mode, the instrument will behave like an E3631A. Select **SCPI ID E3631xA** if you want to return to the original instrument features and functions.

### From the remote interface:

To enable E3631A mode:

```
SYST:PERS:MOD E3631A
```

## Utilities Menu

**Utilities** provides the following features:



### Store and recall state and power on settings

View USB and LAN status as well as configure LAN, GPIB (optional for E36312A and E36313A), and digital IO

Perform instrument self-tests, calibration and configures the instrument's various user settings, date and time

Displays the instrument's error queue

Manage files, including creating screen shots

## Utilities Menu - Store and Recall State

The Utilities menu is shown below.



**Store/Recall** saves and recall states. In general, state files store volatile settings associated with measurements.

The instrument states include volatile settings such as:

- Voltage, current, OVP, OCP delay, OCP state and OCP delay start
- Output sense<sup>1</sup>
- Output state, selected output and couple trigger channel
- Operation mode (Independent, Series, Parallel or Track)
- Output on/off sequencing<sup>1</sup>
- Output LIST settings<sup>1</sup>
- Trigger settings<sup>1</sup>
- Digital I/O output data and bus setting<sup>1</sup>
- Data logger trigger source<sup>1</sup>

1. Applicable for E36312A and E36313A Only



## Store Settings

**Store Settings** creates folders and files (.csv format) to store instrument's state to external memory, or store instrument's state to internal memory. You can store up to 10 states and set them as power-on state.

**Store Settings**

Store Destination Internal

Store in State 0  Set this as power-on state.

\* indicates current power-on state.

Action:  
Store
Dest. :  
Int Ext
Store in  
State 0
Set PwrOn  
Yes No
Store
Back

Menu	Available settings	Description
Action:	Store, Folder	Allows you to either store an instrument's state or to create a new folder.
Dest.:	Int, Ext	Selects whether you want to store a state to internal or external memory. – Internal:\ specifies the instrument's internal memory. – External:\ specifies the USB port on the front panel.
Store in	State 0 to State 9	Selects the state to store state settings.
Set PwrOn	Yes, No	Selects to enable or disable the 'Set this as power-on state' checkbox. Enabling the checkbox will load the selected stored state at power-up.
Store	-	Stores the state.



**Store Settings**

Store Destination **External**

Path

File

Action: **Store**    Dest.: Int Ext    Browse    File Name    Store    Back

Menu	Available settings	Description
Action:	Store, Folder	Allows you to either store an instrument's state or to create a new folder.
Dest.:	Int, Ext	Selects whether you want to store a state to internal or external memory. - Internal:\ specifies the instrument's internal memory. - External:\ specifies the USB port on the front panel.
Browse	-	Allows you to browse and specify the location of the external memory to save the state.
Filename		Specifies the filename. Use the virtual keyboard to enter your desired filename.
Store	-	Stores the state.

**Action: Folder** creates a folder in the external memory.

**Create Folder**

Path

Folder

Action: **Folder**    Browse    Folder Name    Create Folder    Back

Menu	Description
Browse	Allows you to browse and specify the location where the folder will be placed.
Folder Name	Specifies the folder name. Use the virtual keyboard to enter your desired folder name.
Create Folder	Creates a new folder in the specified location.

## Recall Settings

### NOTE

The file you recall must be from same instrument model.

**Recall Settings** allows you to browse to the state in the internal memory or browse to the state file (.csv format) in the external memory to be recalled.

The screenshot shows the 'Recall Settings' menu. At the top, there is a title bar 'Recall Settings'. Below it, there are two settings: 'Recall from' is set to 'Internal' (highlighted in orange), and 'Recall' is set to 'State 0' (shown in a dropdown menu). At the bottom, there is a navigation bar with buttons: 'From:' (with 'Int' and 'Ext' options), 'Recall State 0', 'Recall', and 'Back'. A green arrow points up to the 'Recall' button.

Menu	Available settings	Description
From:	Int, Ext	Selects whether you want to recall an instrument's state from internal or external memory. – Internal:\ specifies the instrument's internal memory. – External:\ specifies the USB port on the front panel.
Recall	State 0 to State 9	Select the state that you want to recall from.
Recall	-	Recall the state.

The screenshot shows the 'Recall Settings' menu. At the top, there is a title bar 'Recall Settings'. Below it, there are three settings: 'Recall from' is set to 'External' (highlighted in orange), 'Path' is an empty text input field, and 'File' is an empty text input field. At the bottom, there is a navigation bar with buttons: 'From:' (with 'Int' and 'Ext' options), 'Browse', 'Recall', and 'Back'. A green arrow points down to the 'Ext' option and a green arrow points up to the 'Recall' button.

Menu	Available settings	Description
From:	Int, Ext	Selects whether you want to recall an instrument's state from internal or external memory. – Internal:\ specifies the instrument's internal memory. – External:\ specifies the USB port on the front panel.
Browse	-	Allows you to browse and specify the state file in the external memory to recall from.
Recall	-	Recall the state.

## Power On Setting

**Power On** selects the state that will be loaded at power-up. This can be either the factory default state (Default), or user-defined states (State 0 to State 9).

Press **Set Power On** to save the setting.

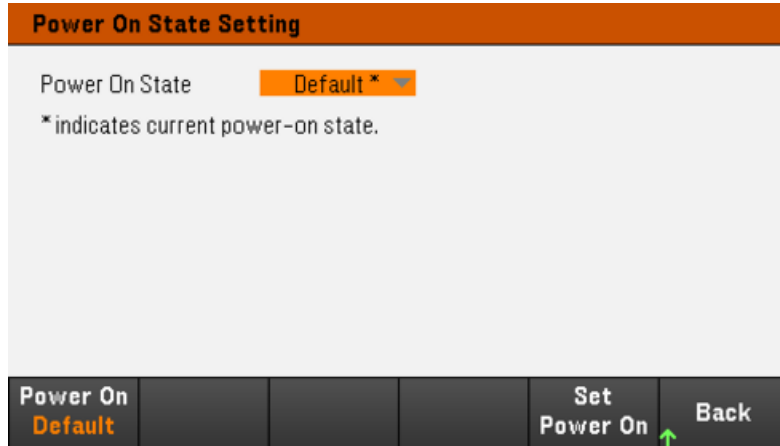

## Set to Defaults

**Set to Defaults** loads the instrument's factory default state.

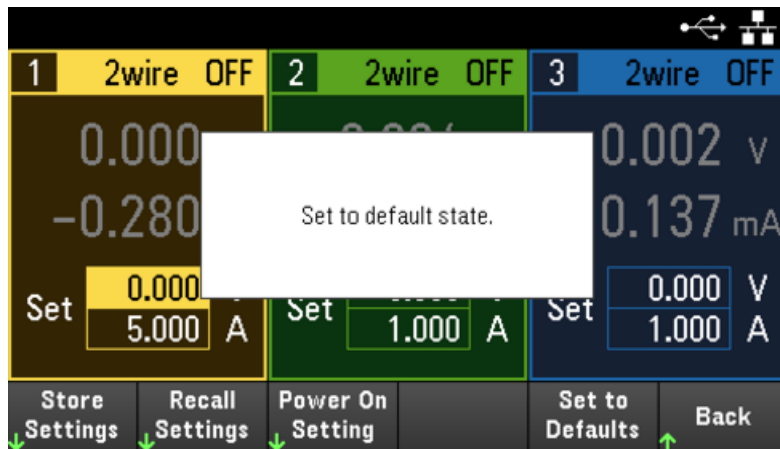

## Utilities Menu - I/O Configuration



**I/O Config** configures the I/O parameters for remote operations over the LAN (optional on some models), USB, or GPIB (optional) interface.



**USB Status** displays the USB connect string for the instrument.

**LAN Status** displays the current LAN setting status for the instrument.

**LAN Reset** resets the LAN using its current settings and enables DHCP and DNS. The **LAN Reset** softkey also clears any user-defined Web Interface password.

**LAN Restart** restarts the networking using its current LAN settings. LAN restart does not clear the user-defined Web Interface password.

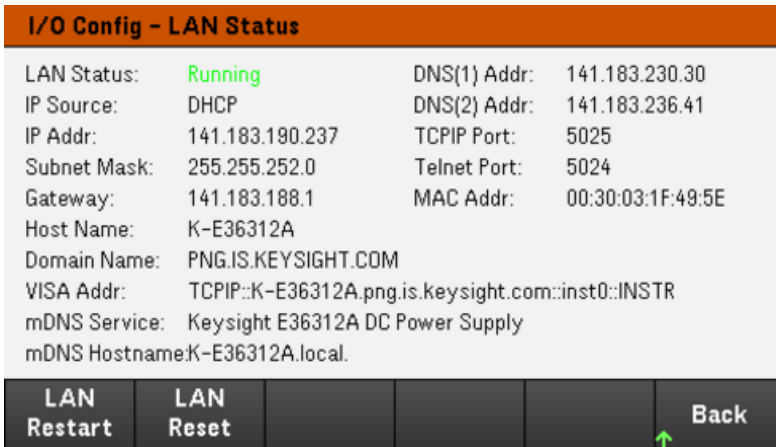

## LAN Settings

**LAN Settings** opens the window shown below. **Set to Defaults** resets the LAN settings to their factory default values.

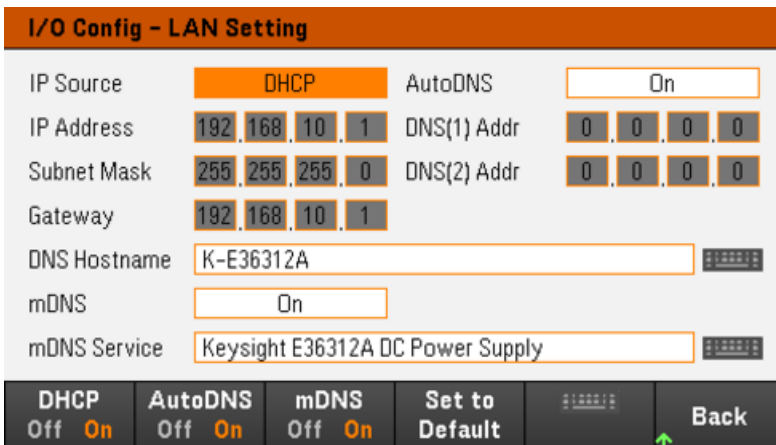

**DHCP** allows DHCP assignment of the instrument's IP address. It also enables the configuration of network parameters based on the protocol selected. **DHCP On** automatically assign a dynamic IP address to a LAN device.

**AutoDNS** allows assignment of the DNS addresses. **AutoDNS On** automatically configures the addressing of the instrument in DNS server

**mDNS** allows modification of the mDNS Service Name.

**Hostname** allows modification of the instrument's DNS hostname.

Digital IO (E36312A and E36313A only)

**Digital IO** configures the rear panel digital port's pin function, polarity and output data applied to the pin.

**Pin** selects the pin for configuration.

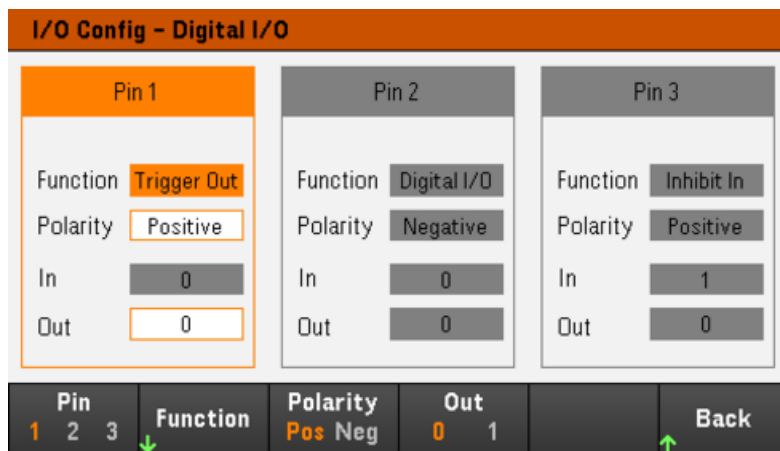

**Functions** configures the function for each pin as shown below.



**Polarity** configures the polarity to Positive (**POS**) or Negative (**NEG**) for the selected pin.

**Out** enables (**1**) or disables (**0**) the output data for the selected pin.

GPIB (optional and applicable to E36312A and E36313A only)

**GPIB** allows you to set the GPIB address to a value from 0 to 30. After changing the address, cycle instrument power for the change to take effect.

## Utilities Menu - Test / Setup



**Test / Setup** provides access to calibration, self-test, as well as configures user preferences, sets the date and time, and accesses the help:



### Calibration

**Calibration** accesses the instrument calibration procedure.

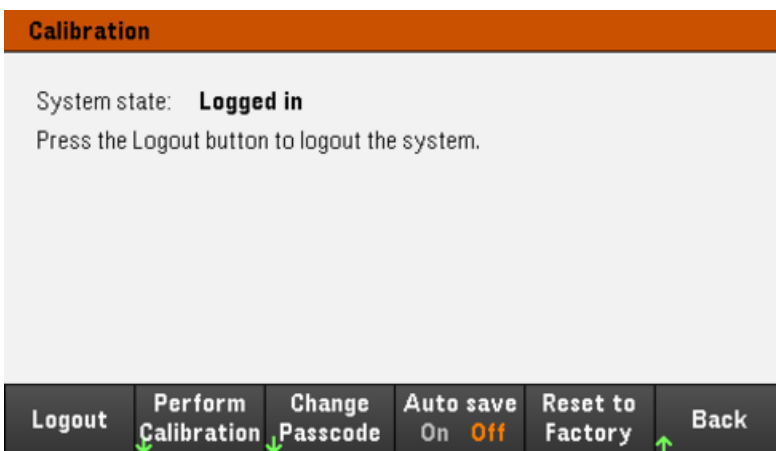

**Perform Calibration** opens the calibration menu. Make sure you have run the self-test before performing any calibration. Refer to "Calibration Adjustment Procedures" in the Service Guide for details.

The default security passcode is 0. Press **Change Passcode** to change the passcode using the numeric keypad. The passcode can be set up to 9 digits.

**Auto save On** will automatically save the calibration data upon logout.

When **Auto save** is Off, press **Cal Save** to save the calibration data.

**Reset to Factory** returns the settings to factory default settings. Pressing this key sanitizes all user-accessible instrument memory except calibration constants and reboots the instrument.

### Self Test

**Self Test** verifies proper instrument operation. Refer to "Self-Test Procedures" in the Service Guide for details.

## User Settings

**User Settings** specifies user preferences that control how the user interacts with the instrument. These settings are stored in non-volatile memory.



### SCPI ID

**SCPI ID** determines the instrument's response to a \*IDN? query. This enables \*IDN? compatibility with existing programs that expect \*IDN? to return a value appropriate to a E3631A.

Choices for each power supply model are:

- E3631A: E3631A
- E3631xA: E36311A, E36312A, E36313A

When set to E3631A mode, the instrument will behave exactly like the E3631A. For example, Output 3 will change to -25 V. In this case, all the remote commands and trigger system will follow the E3631A behavior as well.

### Sound Settings

**Beeper** enables or disables the beeper sound when an error is generated from the front panel or remote interface.

**Key Click** enables or disables the click heard when a front-panel key or softkey is pressed.

### Display Options

**Display Options** configures the display.



You can enable or disable the display and screen saver.

If you turn off the display, press any front-panel key to turn it on again.

By default, the screen saver turns off and blanks the screen after 30 minutes of inactivity. You may disable this screen saver from the front panel only.

The display is enabled when power is cycled, after an instrument reset (\*RST), or when you return to local (front panel) operation. Press **Lock/Unlock** or execute the SYSTem:LOCal command from the remote interface to return to the local state.

**Help Lang** selects the help language for front-panel use: English, French, German, Japanese, Korean, Simplified Chinese or Russian. All front-panel key help, and help topics appear in the selected language. The softkey labels are always in English.

### Date / Time

**Date / Time** sets the instrument's real-time clock, which always uses a 24-hour format (00:00:00 to 23:59:59). There is no automatic setting of the date and time, such as to adjust for daylight savings time.

Use the front panel navigation keys to set the year, month, day, hour, and minute.



Low Range

**Low Range** enables or disables low range current measurement.

Help

**Help** allows you to view the quick reference help topic. Use the arrow softkeys or front panel navigation keys to navigate the desired topic. Press **Select** to view the help content.

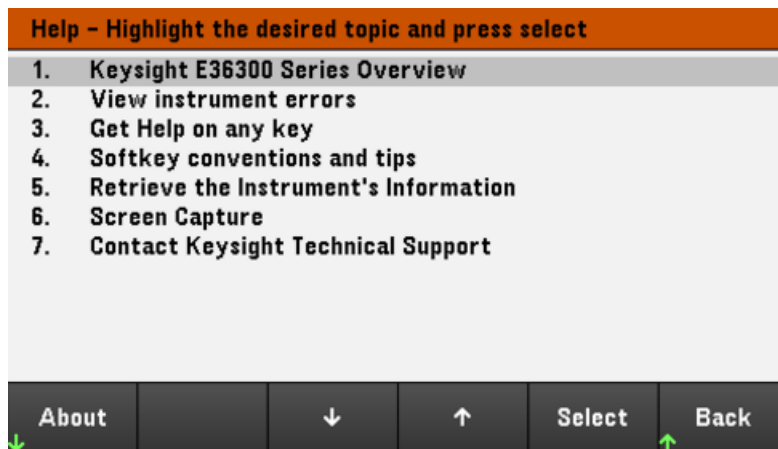

**About** allows you to view the instrument's model number, description and serial number.



## Utilities Menu - Error



**Error** displays the instrument's error queue, which includes up to 20 errors. If there are more than 10 errors on the display, press Next to scroll to the next page.

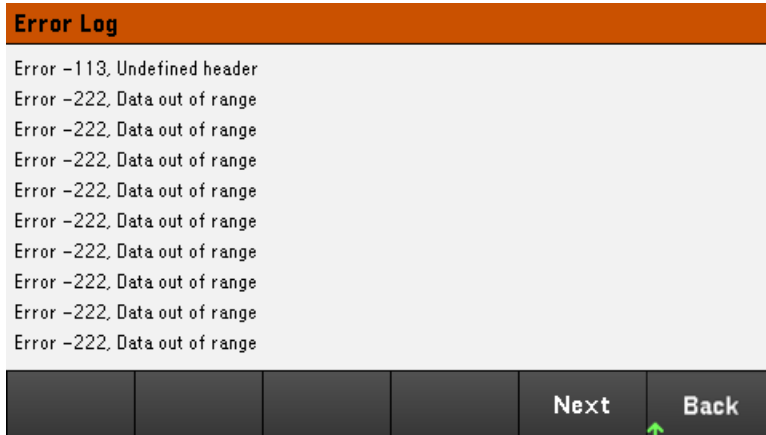

- Errors are stored in the order they are received. The error at the end of the list is the most recent error.
- If there are more than 20 errors in the queue, the last error stored is replaced with -350, "Queue overflow". No more errors are stored until you remove errors from the queue. If there are no errors, the instrument responds with +0, "No error".
- Except for self-test errors, errors will be cleared after you have read them or after an instrument reset.

If you suspect that there is a problem with the power supply, refer to "Troubleshooting" in the Service Guide.

## Utilities Menu - Manage Files



**Manage Files** allows you to create, copy, delete, and rename files and folders on a USB drive attached to the front panel. It also allows you to capture the current screen to either a bitmap (\*.bmp) or portable network graphics (\*.png) file. This is the default option, as shown below.



### Action

**Action** specifies the action to perform. Pressing **Capture Display** saves a screen capture of the display at the moment that you pressed **[Meter View]** for more than 3 seconds.



**Delete** - To delete a file or folder, press **Delete** and **Browse** to the folder or file to delete. Press **Browse** > **Perform Delete** > **Back**.

**Folder** - To create a folder, **Browse** to the external location for the folder, press **Folder Name**, enter a folder name and press **Done**. Press **Create Folder** > **Back**.

**Copy** - To copy a file, press **Copy**. **Browse** to the file to be copied and press **Select**. Press **Copy Path** and select an external path for copying. Press **Perform Copy** > **Back**.

**Rename** - To rename a file or folder, press **Rename**. **Browse** to the folder or file to be renamed and press **Select**. Press **New Name**, enter a new name and press **Done**. Press **Perform Rename** > **Back**.

### Browse

**Browse** selects the file or folder upon which the action will be performed. Use the front-panel navigation keys to navigate through the list. The left and right arrows contract or expand a folder to hide or show its files.

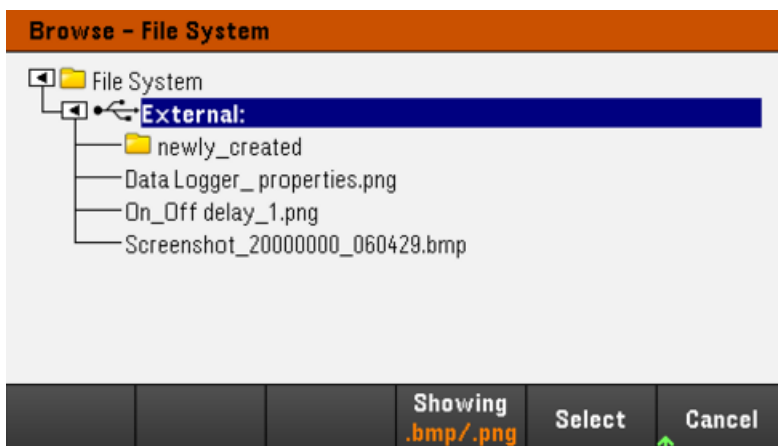

Press **Select** or **Cancel** to exit the browse window.

## File Name

**File Name** allows you to use the front-panel arrows, the **[Enter]** key, and the softkeys to enter a filename. Use the front-panel arrows to point to a letter, and **Previous Char** and **Next Char** to move the cursor in the area where the name is entered. In the image below, there is no **Next Char** softkey because the cursor is at the end.



Press **Done** or **Cancel** to finish.



# 3 Characteristics and Specifications

## NOTE

For the characteristics and specifications of the E36300 Series programmable DC power supplies, refer to the datasheet at <http://literature.cdn.keysight.com/litweb/pdf/5992-2124EN.pdf>.





This information is subject to change without notice.

© Keysight Technologies 2017-2018  
Edition 4, August 2018  
Printed in Malaysia



E36311-90001

[www.keysight.com](http://www.keysight.com)